

Power Syntax®

SINGLE POLE CONNECTOR SERIES

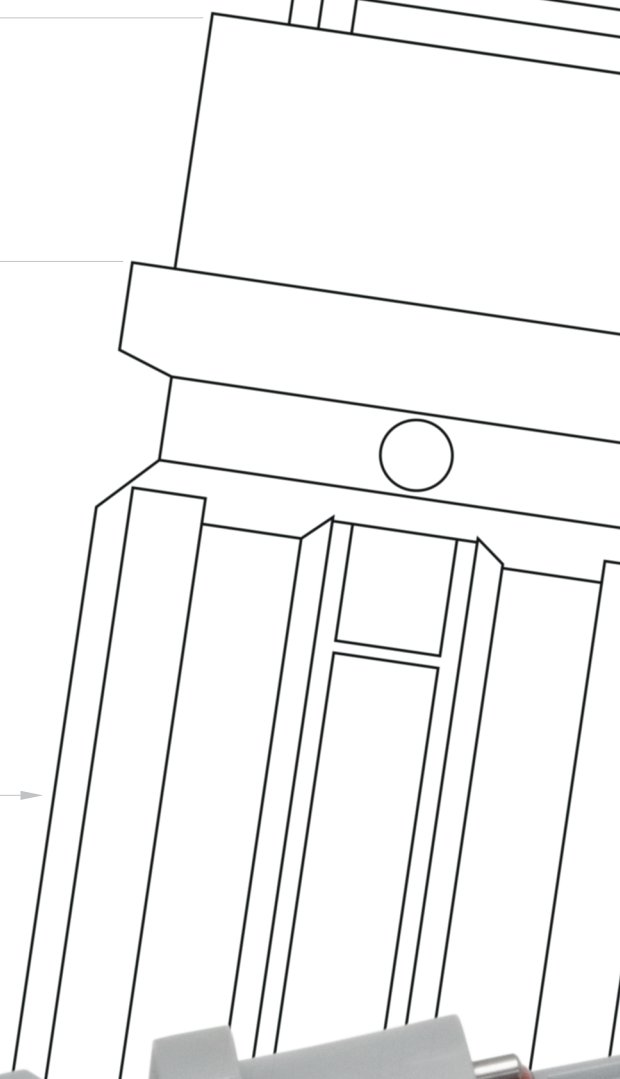

Your idea
is our next
accomplishment

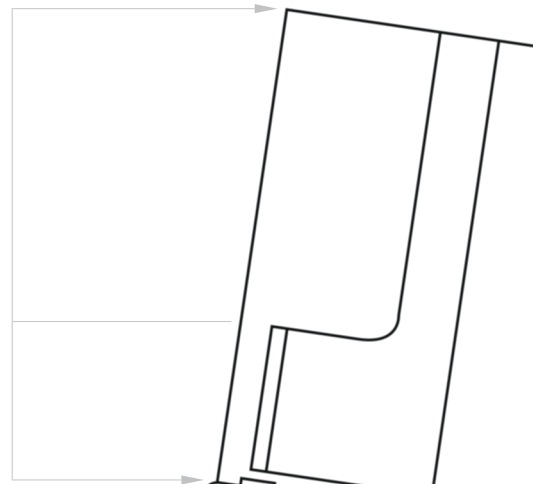

**Power
Syntax®**

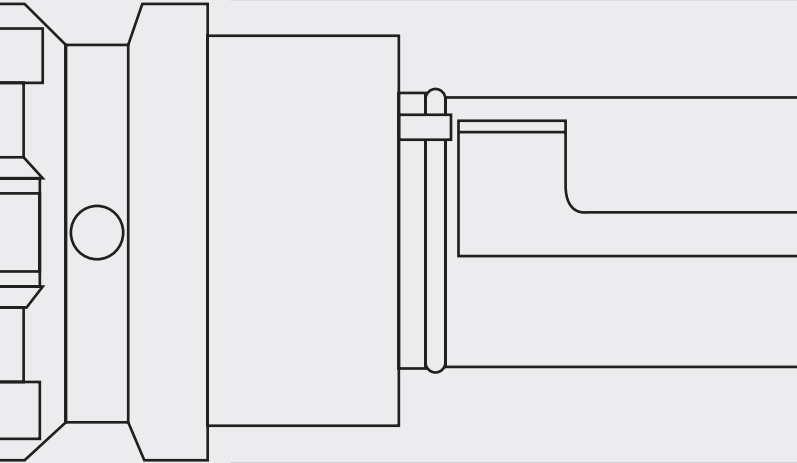

VALENTINI *SYNTAX®*
PBOX

Inventors, manufacturers, innovators.

Valentini is a dynamic, ever-evolving company operating in over 60 countries worldwide. For more than 30 years we have actively researched, designed and manufactured connectors for power, signal and hybrid applications.

Our products have been used all over the world to manage power and electric signals in fields such as industry, automotive, broadcasting, shipbuilding & ship to shore power, international sporting events, live shows, military & national emergency management by agencies such as the Italian Civil Protection Department, and so many more.

Valentini is an environmentally-aware company where respect for the environment is an integral part of the manufacturing process. Our team is motivated and mindful of details, as we are aware of how important details are in our pursuit of uncompromised quality and utmost reliability.

INDEX

04 PowerSyntax connectors series

General features
 Typical applications
 Technical data
 Rated current
 Drain IP2X 
 Technical features

08 Chain Pilot

Technical data pilot microswitch
 Panel source and panel drain
 Panel circuits
 Contacts
 Overall dimensions

12 Chain Pilot Box

Product overview
 Technical features
 Technical data
 Possible configurations
 Overall dimensions

18 Basic panel

Product overview
 Contacts
 Overall dimensions

24 Shelter Evolution

Short version
 Medium version
 Long version
 Part numbers | Overall dimensions

30 PowerSyntax 45 | 90

Contacts | Overall dimensions

34 Line connectors

Short, standard and oversize body
 Contacts
 Overall dimensions
 Machined adaptors

40 Crimping data

42 Vertical PowerSyntax

Overall dimensions | Contact

45 Cable protection and management

46 Premium Power Cables

Part numbers

48 Phase inverters / Adaptors

50 S2W 480 amp PowerSyntax

Multiplier | Adaptor | Phase inverter

52 InsuLugger

Part numbers | Overall dimensions

54 SyntaxLock

56 Protection caps

58 Part Number explanation



PowerSyntax®

connectors series

PowerSyntax family of single pole connectors for high currents.



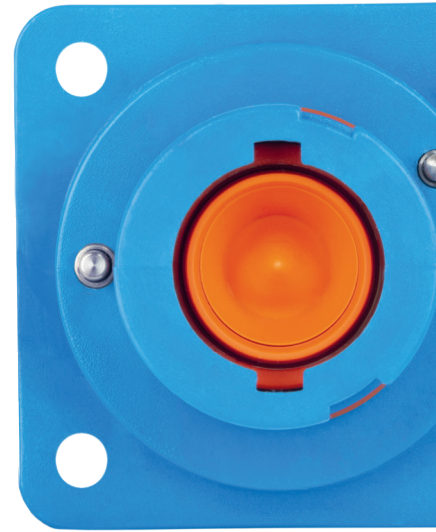









The new PowerSyntax series of powerlock-style single pole connectors are specifically suited for the electrical supply management for currents up to 480amp or 750amp. Although fully intermateable with the original (and all the previous Syntax versions), the new PowerSyntax features a number of mechanical and technical enhancements which have been designed and incorporated to redefine the standards on this category of connectors as for safety, reliability, ease of handling and robustness in the harshest conditions.



General features

- Powerlock compatible
- Intermateable with other versions
- CE compliant
- EN/ESI compliant
- Contact retained within the thermoplastic housing with a flame-retardant UL94-VO plastic pin
- Quick assembling and disassembling, no special extracting tools are needed
- Heavy-duty ergonomic hand grip, with sides specifically designed for easy pushing/pulling when mating/unmating
- Metric thread M40 cable gland IP68 watertight compliant with EN/CE, adapters available for cables over 32 mm diameter
- Multipoint contact area
- Silver Plated Contacts
- Mechanically keyed to prevent mating errors
- High impact bodies
- Screw, Crimp and Lug terminals to facilitate cables from 25mm² to 300 mm²
- Permanent marking to identify phase/line and safety information embossed on connector's body

Identification color codes

	Ground	Neutral	Line 1	Line 2	Line 3
Europe & UK					
UK (old)					
Australia					
U.S.A.					



Typical applications

- Electrical power systems
- Power distribution
- Wind power
- Solar energy
- Battery units
- Mobile generators
- Industrial vehicles
- Railway installations
- Military installations
- Load banks
- Backup power systems
- Electrical power supply companies
- Heavy industry
- Outdoor concerts and sporting events
- Outdoor broadcasting
- Theatres

Technical data

- **Number of contacts:** single pole
- **Max continuous current rating with brass or bimetal contact:** 480amp
- **Max continuous current rating with copper contact:** 750amp
- **Operating Voltage:** 1000V AC / 1000V DC
- **Test Voltage:** 4500 V AC
- **Short Circuit Rating:** 16.1kA (1 sec) 13.8kA (2sec) 11.5kA (3 sec) 35.5kA (peak)
- **Insulation Resistance:** >5000 MOhm @500V
- **IP rating when mated:** IP67
- **Protection against electric shock:** IP2X
- **Contact resistance:** <0.1 mOhm
- **Housing material:** high temperature thermoplastic
- **Flammability:** UL94 V0
- **Coupling method:** bayonet lock with secondary locking pin
- **Number of mating cycles:** >500
- **Operating temperature:** -30°C/+125°C
- **Contact termination tightening torques:**
 - Set screw 12Nm
 - M12 threaded post 30Nm
 - M12 threaded hole 30Nm
 - EasiLug 20Nm
 - ComLug L (480A) 30Nm
 - ComLug L2 (750A) 30Nm
 - ComLug XL (750A) 30Nm



Rated current

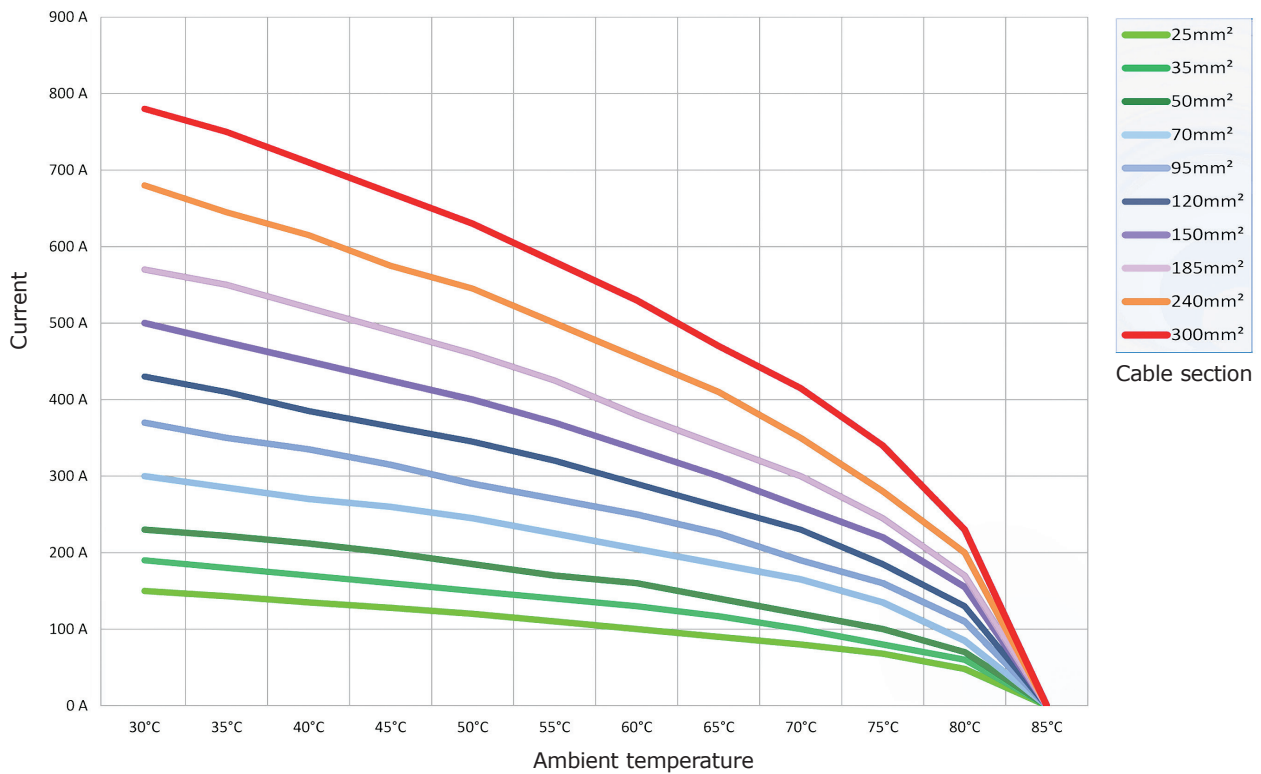

Data for 90° Copper cable ratings - For aluminium cable, ratings decrease by approximately 25%

IP2X drain contact safety lock

Patented by Syntax

On our drain single pole connectors, the IP2X protection is obtained through a patented safety lock of the sharp-pointed insulated cap. This proprietary solution prevents pushing the contact inwards with fingers and provides mechanical lock in case of improper pushing of the contact.

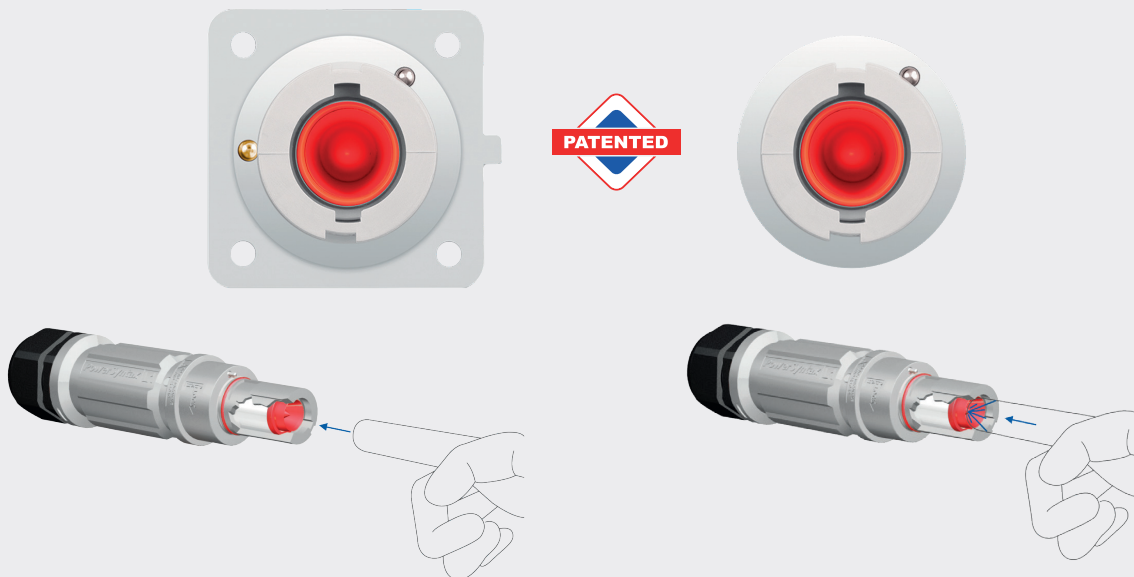



Multilouver contact band and locking mechanism

To prevent a faulty retention of the contact band **1** and to ensure the efficiency of the connection, we adopted a solution which keeps the multilouver spring loaded band positively locked. The contact band is held in its locked position by a special ring, on which a 2.5 ton. pressure has been applied **2**. This solution prevents derailment of the multilouver contact band **3**.



Source contact IP2X threaded protection

The touch-proof protection on source contacts features a threaded attachment. A breakage of the insulation caps is a risk for the operators' safety. Thanks to this solution, the touch-proof cap is threaded and then blocked with specific adhesives. The bond between the protective elements and the live parts is strengthened, improving safety through a reduced exposure of the metal parts, as a portion of the cap will remain in position even in case of damage.

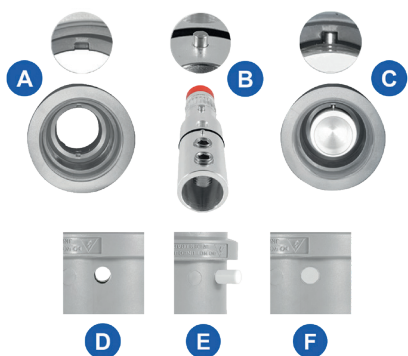

PowerSyntax contact guide pin

For easy alignment of the holes on contact and insulating body, and quick insertion of the white dowel pin, the PowerSyntax contacts feature a guide pin with a corresponding recess in the insulator. After locating recess **A** in the body, find guide pin **B** on the contact, then insert guide pin **B** inside recess **A**, as shown in picture **C**. For contact fastening, after locating hole **D** on the body, insert dowel pin **E** in hole **D**. Contact retention is then completed **F**.

Ergonomics shapes our world

The external shell has an ergonomic design which grants optimal handling and grip, also when operating with gloves. In particular, the sides of the hand grip are specifically designed for easy pushing/pulling of the connector when mating/unmating.

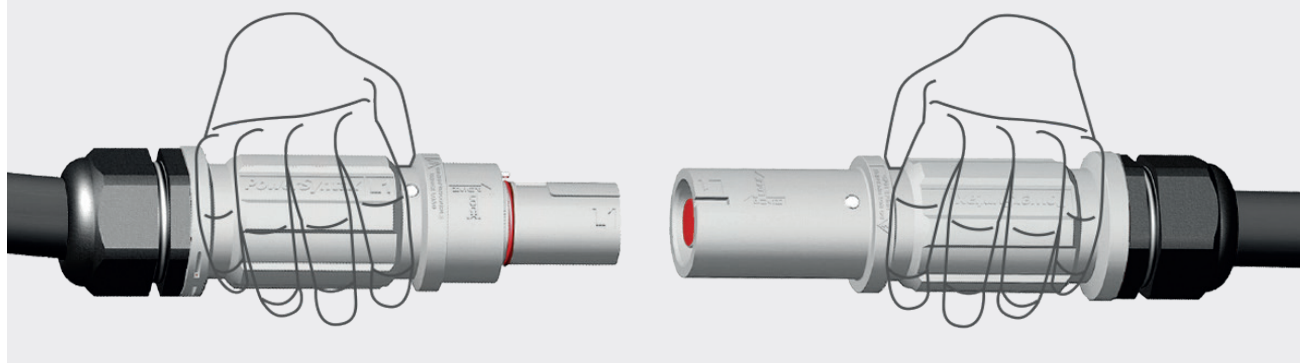



Chain pilot

Drain and source panel connectors
with **Microswitch**

The new CHAIN PILOT system is an evolution of the PowerSyntax panel-mount single pole connectors. VALENTINI - Syntax® has become the first manufacturer in the world to have developed and marketed powerlock-style panel-mount connectors with built-in microswitch (international patent). Now protective electrical interlocking and/or additional controls can now be obtained, allowing constant monitoring of all the conductors in a power circuit. When a Chain Pilot is mated, a spring device pressed by the line connector is operated, activating the pilot microswitch housed in the rear of the flange. The Chain Pilot connectors are suitable for currents up to 480amp or up to 750amp. They are fully intermateable with standard PowerSyntax or other powerlock-style connectors.

Technical data



Pilot microswitch

- Switching function: Changeover switch (spdt momentary)
- Number of poles: 1 - pole
- Connections: Quick-connect terminal, 2.8 x 0.5, sealed
- Mechanical life endurance: 10E6
- Rating IEC / Rating North America: 10 (3) a 250 v ac 10E3
- Design: DIN 41635 B
- Contact resistance (new condition): < 100 (1 A 12 V DC Mohm)
- Insulation resistance (new condition): > 100 (500 V DC) Mohm
- Voltage strength at 250V:
 - function insulation / basic insulation 1500 V
 - small contact distance 500 V
- Insulation spacing: acc. to EN 61058 for reinforced or double insulation
- Flammability: UL 94 V-0
- Glow wire test temperature: 850 °C

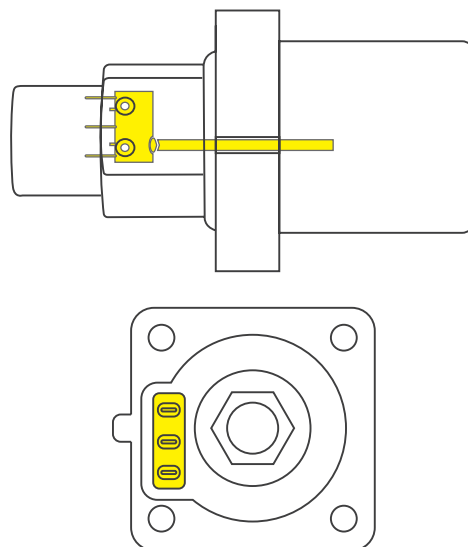

Activation button

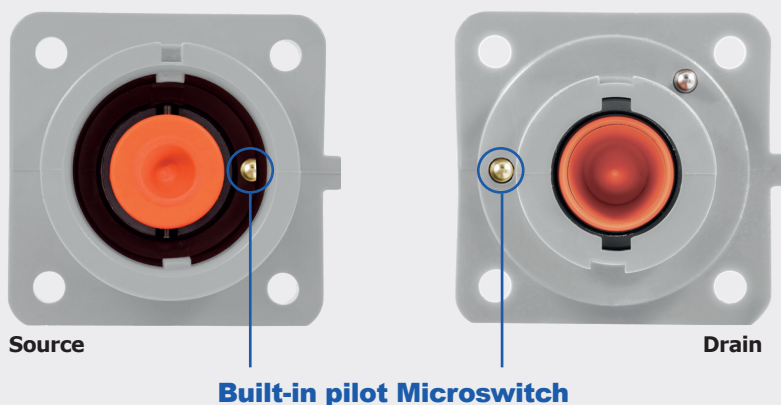

Panel source With microswitch

On the panel source, the spring device activating the microswitch is placed inside the mating part of the connector's shell.

Panel drain With microswitch

On the panel drain, the spring device activating the microswitch is placed outside the mating part of the connector's shell.

Examples of connection applications

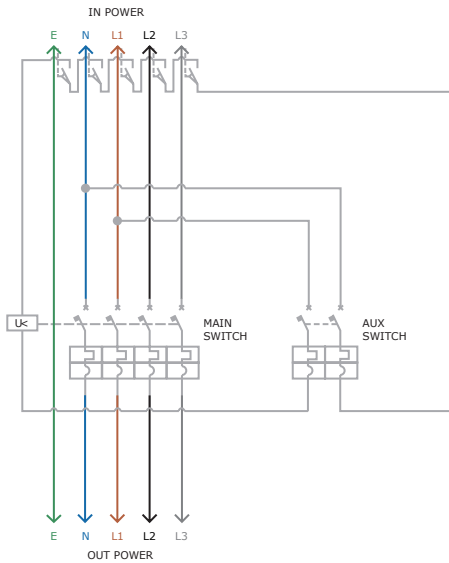

5 Panel drain circuit

5 PowerSyntax series panel drain connectors with built-in microswitches for phase conductors "L1, L2 & L3", neutral "N" and ground "E".

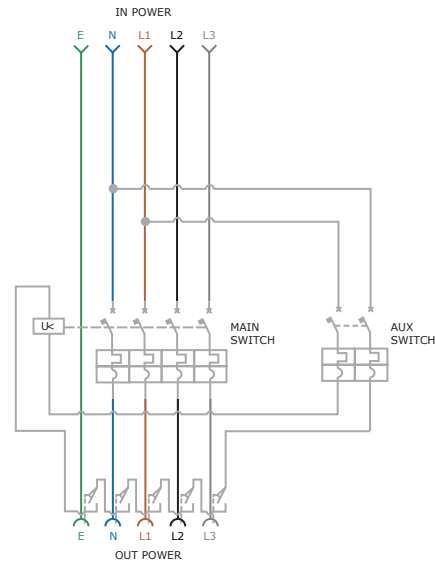

5 Panel source circuit

5 PowerSyntax series panel source connectors with built-in microswitches for phase conductors "L1, L2 & L3", neutral "N" and ground "E".

Contacts

The PowerSyntax Chain Pilot Panel connectors are equipped with different contact types, depending on current rating (480amp or 750amp) and cable terminations.

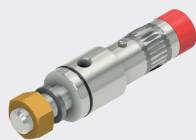

M12 threaded post

M12 threaded-post contact, up to 480 amp or 750 amp (all-copper contact). Lug terminal retained through M12 nut.

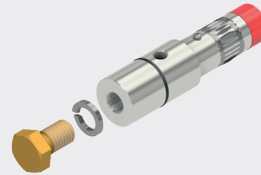

M12 threaded hole

M12 threaded-hole contact, up to 480 amp or 750 amp (all-copper contact). Lug terminal retained through M12 bolt.

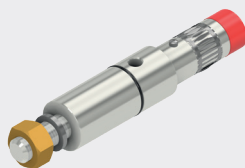

Extended length contact M12 threaded post

M12 threaded-post contact, up to 480 amp or 750 amp (all-copper contact). Lug terminal retained through M12 nut.

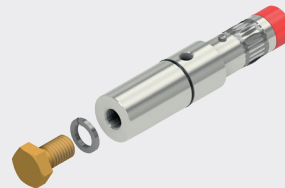

Extended length contact M12 threaded hole

M12 threaded-hole contact, up to 480 amp or 750 amp (all-copper contact). Lug terminal retained through M12 nut.

Overall dimensions

Chain pilot panel connector

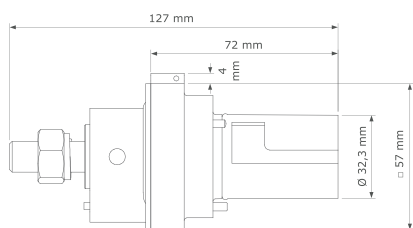

Panel drain
with M12 threaded post

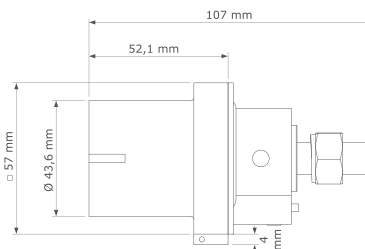

Panel source
with M12 threaded post

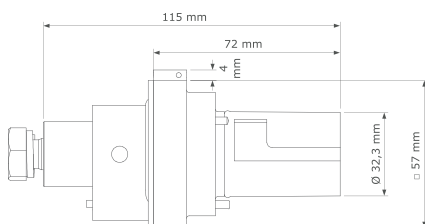

Panel drain
with M12 threaded hole

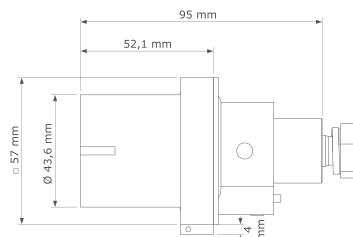

Panel source
with M12 threaded hole

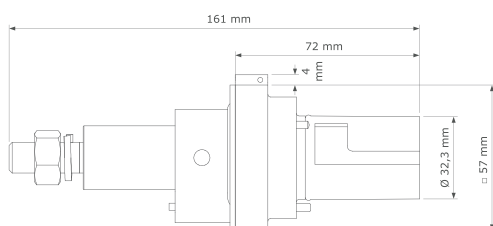

Panel drain
Extended length contact with M12 threaded post

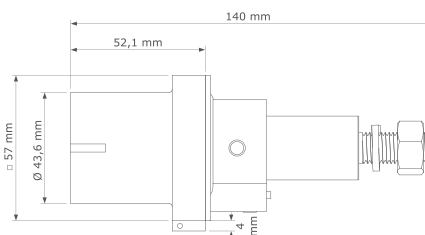

Panel source
Extended length contact with M12 threaded post

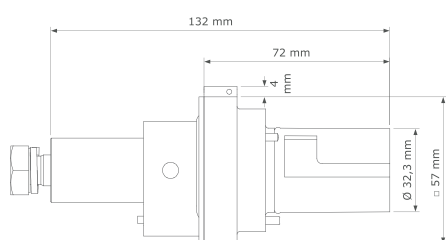

Panel drain
Extended length contact with M12 threaded hole

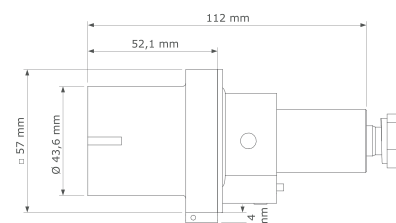

Panel source
Extended length contact with M12 threaded hole

Panel mount cut-out dimensions

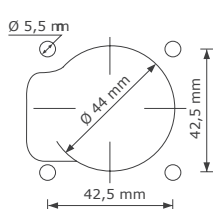

Panel drain front/rear

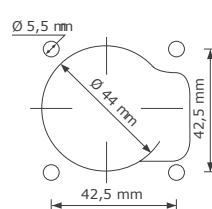
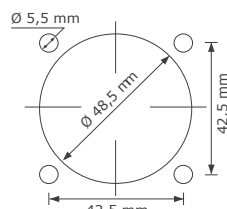

Panel source front/rear

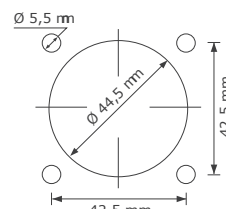



Chain Pilot Box

The non-sequential safety box

The PowerSyntax Chain Pilot box features a set of PowerSyntax Chain Pilot connectors with L1+L2+L3+N+PE (or L1+L2+L3+PE), each one with its built-in microswitch. The connector's microswitches control an auxiliary circuit connected to an external device (breaker, contactor, etc.), so that the system will only be activated once all the mechanically keyed cable connectors have been inserted in the corresponding panel-mount connectors on the Chain Pilot Box. So there is no need to respect a sequential order when mating or unmating your connectors, unlike other Powerlock-compatible boxes.

All connectors will de-energise should one become disconnected when in use.

Product overview

- Insert all the cable connectors to activate the breaker or protection device
- All connectors will de-energise should one become disconnected when in use
- Built-in microswitch for electrical interlock on all connectors
- No mechanical locks / longer lifespan
- Ensures safe connection of all phases, neutral and earth
- Electrical safety guaranteed
- International patent on connectors

Supply notice

Environmental caps supplied as a standard to ensure IP67 even when connectors are unmated.



Chain Pilot panel connectors are patented by Syntax

Technical features

- Intermateable with standard PowerSyntax or other powerlock-style connectors
- Microswitch-controlled auxiliary circuit ensures that the system will only be energised when all 5 connectors on the box have been mated
- Total electrical safety as all connectors are de energised should one become disconnected
- Color coded connectors
- 5-pole (E-N-L1-L2-L3) or 4-pole (E-L1-L2-L3) system with Panel Drain or Source connectors
- Mechanically keyed connectors to prevent mating errors.
- Secondary lock for added mechanical safety
- IP2X finger-proof protection
- 2U 19" rack-mountable box
- IP67 rating on connectors' front mating side
- Microswitch-controlled auxiliary circuit ensures that the system will only be energised when all connectors on the box have been mated



Technical data

- Rated current: 480amp or 750amp
- Rated voltage: 1000V AC / 1500V DC
- Color coding:
 - EUROPE:** color coded connectors and panel inscriptions (E-green, N-blue, L1-brown, L2-black, L3-grey)
 - UK (old):** color coded connectors (E-green, N-black, L1-red, L2-yellow, L3-blue)
 - AUSTRALIA:** color coded connectors (E-green, N-black, L1-red, L2-white, L3-blue)
 - USA:** color coded connectors (E-green, N-white, L1-black, L2-red, L3-blue)
- Model: source or drain
- Contact material: silver plated copper

- Box material: high temperature thermoplastic
- Rack space: 2U or 2.5U
- Endurance: 500+ connection cycles
- Degree of protection (connectors front side): IP67 when mated of with environmental caps fitted (IP67 caps supplied as a standard)
- Degree of protection (connectors without caps): IP2X finger-proof
- Flammability: UL94 - V0
- Operating temperature: -30°C to +85°C

Safety notice

The PowerSyntax Chain Pilot Box should only be installed and operated by suitably qualified persons.



Choose between 256 configurations

Make your own Chain Pilot Box

Choose between a wide range of options: 4 or 5 poles, color coding by geographical region, source or drain connectors, up to 480A or up to 750A, 2U or 2,5U of box height and contact type, threaded post or threaded hole, serial or parallel internal wiring.

1. Choose your connector style

The PowerSyntax Chain Pilot connectors are available in Panel Drain and Panel Source versions.

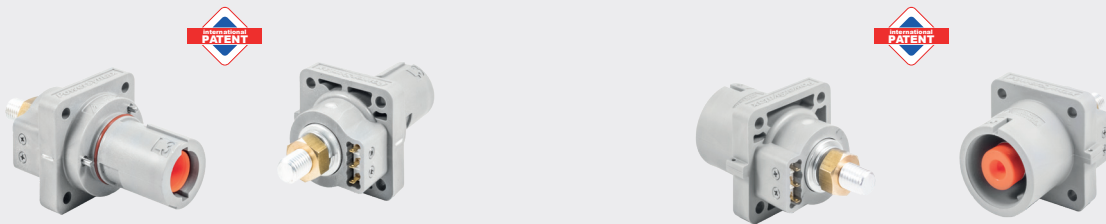

Panel drain

With microswitch

On the panel drain, the spring device activating the microswitch is placed outside the mating part of the connector's shell.

Panel source

With microswitch

On the panel source, the spring device activating the microswitch is placed inside the mating part of the connector's shell.

2. Choose the number of poles

The Chain Pilot Box can be ordered with the standard 5-poles (G - N - L1 - L2 - L3) or in the 4-poles (G - L1 - L2 - L3) version.



5-poles version



4-poles version

3. Choose the color coding

The PowerSyntax Chain Pilot connectors can be coded for Europe, UK (old), Australia and U.S.A. color schemes.

Identification color codes (5-POLES)

	Ground	Neutral	Line 1	Line 2	Line 3
Europe & UK					
UK (old)					
Australia					
U.S.A					

Identification color codes (4-POLES)

	Ground	Line 1	Line 2	Line 3
Europe & UK				
UK (old)				
Australia				
U.S.A				

4. Choose the contact's terminal

The PowerSyntax Chain Pilot panel connectors in the Chain Pilot Box are equipped with different contact types, depending on current rating (480amp or 750amp) and cable terminations.

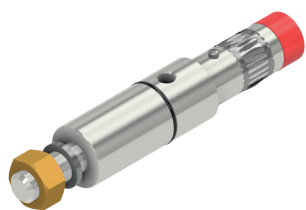

Extended length contact M12 threaded post

M12 threaded-post contact, up to 480 amp or 750 amp (all-copper contact).
Lug terminal retained through M12 nut.

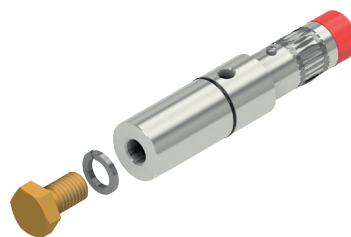

Extended length contact M12 threaded hole

M12 threaded-hole contact, up to 480 amp or 750 amp (all-copper contact).
Lug terminal retained through M12 bolt.

5. Choose the box height

Pick the right box for your rack, we can provide two options: 2U and 2.5U. Both choices are available for the 4-poles or the 5-poles versions.

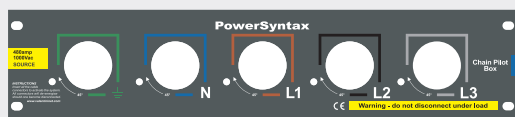

Box height: 2U (89mm)

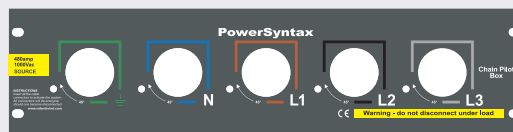

Box height: 2.5U (108mm)

6. Choose the internal wiring

Depending on the control circuit you choose to employ, the internal wiring of the connectors microswitches can be performed in two different ways: serial or parallel.

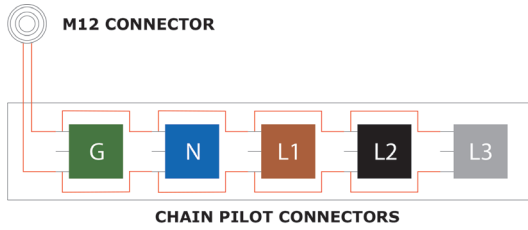

This type of wiring is employed when using circuit breakers (MCB / MCCB) equipped with minimum voltage coils or contactors.

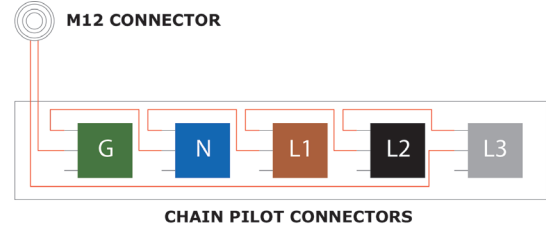

This type of wiring is employed when using circuit breakers equipped with shunt trip coils.

Overall dimensions

Chain Pilot Box

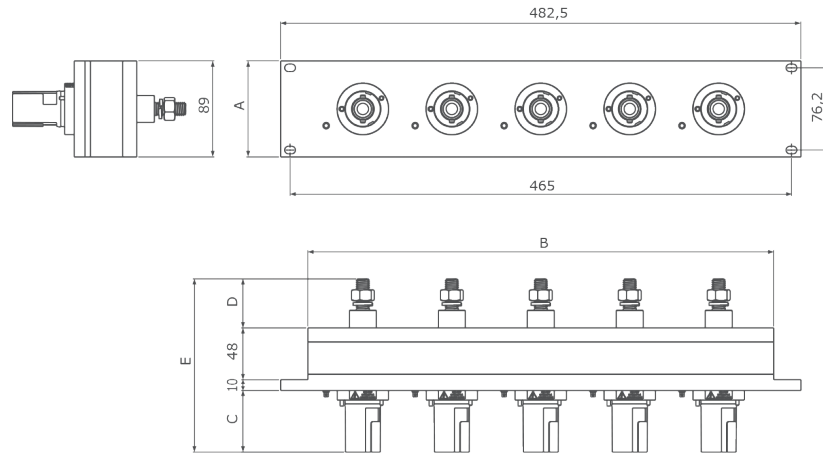

Type	Poles	Units	Contact	A	B	C	D	E
Drain	4	2U	M12 post	89 mm	349,5 mm	57 mm	46 mm	161 mm
Drain	4	2U	M12 hole	89 mm	349,5 mm	57 mm	16,3 mm	131,3 mm
Drain	4	2.5U	M12 post	108 mm	349,5 mm	57 mm	46 mm	161 mm
Drain	4	2.5U	M12 hole	108 mm	349,5 mm	57 mm	16,3 mm	131,3 mm
Drain	5	2U	M12 post	89 mm	432 mm	57 mm	46 mm	161 mm
Drain	5	2U	M12 hole	89 mm	432 mm	57 mm	46 mm	161 mm
Drain	5	2.5U	M12 post	108 mm	432 mm	57 mm	46 mm	161 mm
Drain	5	2.5U	M12 hole	108 mm	432 mm	57 mm	16,3 mm	131,3 mm
Source	4	2U	M12 post	89 mm	349,5 mm	35 mm	46 mm	139 mm
Source	4	2U	M12 hole	89 mm	349,5 mm	35 mm	16,3 mm	109,3 mm
Source	4	2.5U	M12 post	108 mm	349,5 mm	35 mm	46 mm	139 mm
Source	4	2.5U	M12 hole	108 mm	349,5 mm	35 mm	16,3 mm	109,3 mm
Source	5	2U	M12 post	89 mm	432 mm	35 mm	46 mm	139 mm
Source	5	2U	M12 hole	89 mm	432 mm	35 mm	16,3 mm	109,3 mm
Source	5	2.5U	M12 post	108 mm	432 mm	35 mm	46 mm	139 mm
Source	5	2.5U	M12 hole	108 mm	432 mm	35 mm	16,3 mm	109,3 mm

Extra safety, even in the packaging

Every detail is important to us

We care about every aspect regarding the safety of our products, from the starting design to the final delivery. Every single Chain Pilot Box is enclosed in a polyethylene shell, inserted in a sealed cardboard package and shipped in another cardboard box, for further protection.



The IP67 caps are supplied as a standard

IP67 protection of the Chain Pilot Box is fully ensured when all the connectors are mated or all the environmental caps are fitted.





Basic panel connector

Panel source, panel drain,
480 or 750 Amp

Discover our innovative, powerlock compatible, single pole panel connectors: many options that will improve your productivity while bringing you peace of mind on all electrical insulation and safety-related issues. With no compromises on connectors' design and performances.

Basic panel connector

A classic that never stops looking ahead

Our Basic panel connector is thought for someone who faces new challenges on a daily basis and designed with the reliability of a product tested by 16 years of work on the field and tens of thousands of connectors manufactured.

Product overview

Specific housing for protection cap lacing moulded on the plastic body of the flange. IP2X protection through patented drain contact lock and source finger protection to prevent touching live parts. Contact to housing retention through flame-retardant UL94-VO plastic cotter pin. No special assembling tools needed. Secondary locking safety system. Front or rear panel mount. Optional M5 threaded fittings available for rear panel mount. Permanent phase / line identification and safety information markings embossed on connector's shell. No additional information stickers applied. SPX 4 480 amp and SPX 7 750 amp versions available. M12 contacts with M12 threaded post or M12 threaded hole supplied as a standard. Other contact options available on request. For secondary lock release, use SyntaxLock or standard release key.

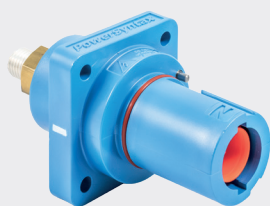

Panel drain
Front view



Panel drain
Rear view



Panel source
Front view

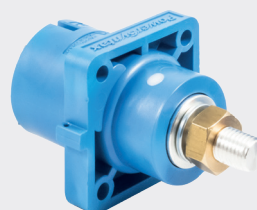

Panel source
Rear view

Contacts

for Basic panel connectors

The PowerSyntax Panel connectors are equipped with different contact types, depending on current rating (480 amp or 750 amp) and cable terminations.

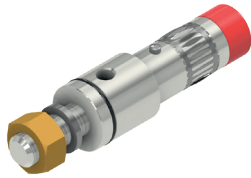

M12 threaded post

Up to 480 amp or 750 amp (all copper contact). Lug terminal retained through M12 nut. Used as a standard on Basic panel-mount connectors. Tightening torque 30Nm.

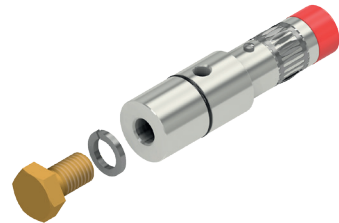

M12 threaded hole

Up to 480 amp or 750 amp (all copper contact). Lug terminal retained through M12 bolt. Used as an alternative for M12 threaded-post contacts on Basic panel-mount connectors. Tightening torque 30Nm.



Crimp contact

Crimp contact, up to 750 amp, and up to 300 mm² cable sections. The position and number of cable compressions vary according to the different cable sections. Cable stripping length is 42 mm.

For all crimping data see the section starting from page 40

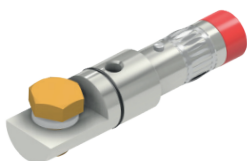
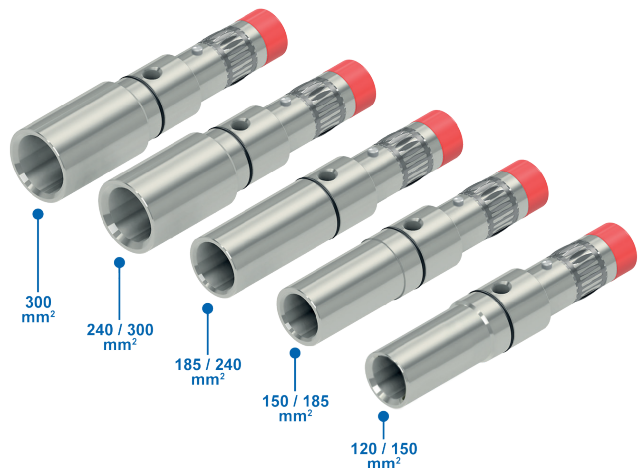

SPY ComLug L

Entirely designed and produced by Syntax, contact up to 480 amp and suitable for cable lug terminals up to 120 mm². Tightening torque 30Nm.

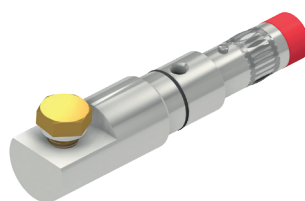

SPY ComLug L2

Entirely designed and produced by Syntax, contact up to 750 amp and suitable for cable lug terminals up to 240 mm². Tightening torque 30Nm.

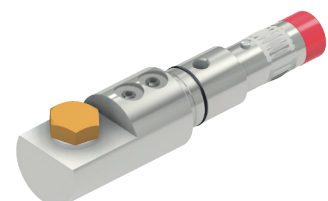

SPY ComLug XL

Entirely designed and produced by Syntax, contact up to 750 amp and suitable for cable lug terminals up to 300 mm². Tightening torque 30Nm.

Set screw contact

Up to 480 amp. Cable retained through reduction sleeve (25-150 mm²) and set screws suitable reduction sleeve is included. Used as a standard on SPX/SPZ 480 amp line source/drain connectors, the set screw contact is also available for panel connectors on request. Tightening torque 12Nm.

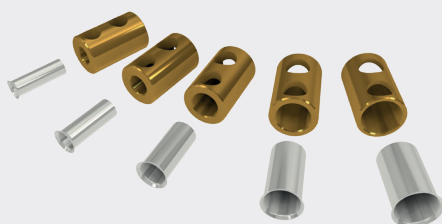
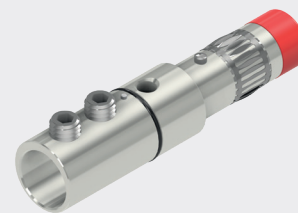

Sleeve adapter system for set screw contacts

The ultimate solution for 25 to 95 mm² cables.

On other connectors on the market, multiple concentric sleeves are used to reduce the cable section from 150 or 120 mm² down to the smaller section specifically needed. The thoughtful design and the mechanical reliability of our sleeve adapter eliminates the need to use multiple concentric sleeves.

Cable section (class 5)	25 mm ²	35 mm ²	50 mm ²	70 mm ²	95 mm ²	120 mm ²	150 mm ²
Recommended sleeve adapter (p/n)	SPX-RED025	SPX-RED035	SPX-RED050	SPX-RED070	SPX-RED095	-	-
Cable strip length	33 mm	33 mm	33 mm	33 mm	33 mm	33 mm	33 mm
Set screw tightening torque	12Nm	12Nm	12Nm	12Nm	12Nm	12Nm	12Nm
M10 hex set screw (2pcs)	allen key size 5	allen key size 5	allen key size 5	allen key size 5	allen key size 5	allen key size 5	allen key size 5

Contacts for aluminium cables for currents up to 480 amp

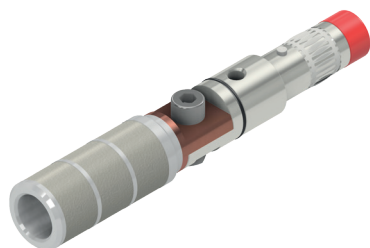

SPY EasiLug - Bimetal

Complete EasiLug contact with bi-metal (aluminium/copper terminal) for aluminium cables. Used as a standard on SPY EasiLug line connectors for aluminium cables, this contact type is also available for panel-mount connectors on request. Tightening torque 20Nm.

For all crimping data see the section starting from page 40

Overall dimensions

Basic panel connector

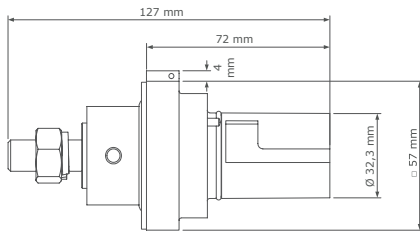

Basic panel drain
with M12 threaded post

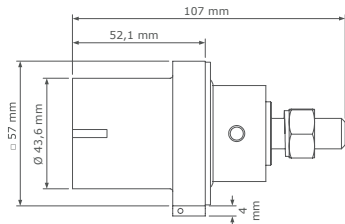

Basic panel source
with M12 threaded post

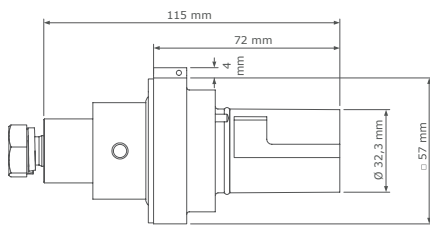

Basic panel drain
with M12 threaded hole

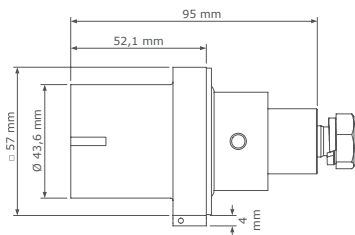

Basic panel source
with M12 threaded hole

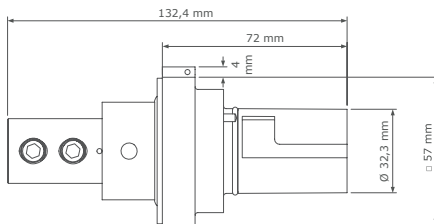

Basic panel drain
with set screw contact

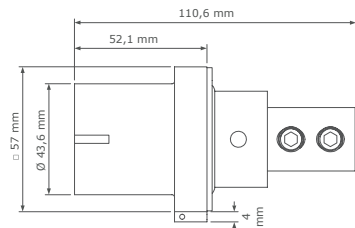

Basic panel source
with set screw contact

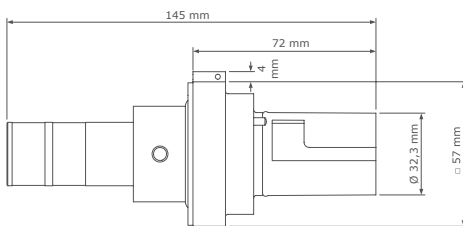

Basic panel drain
with crimp contact

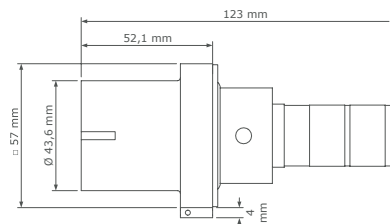

Basic panel source
with crimp contact

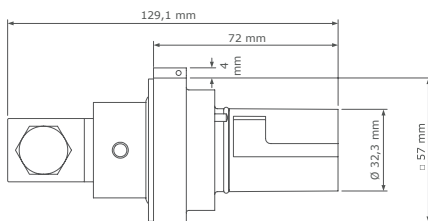

Basic panel drain
with ComLug L

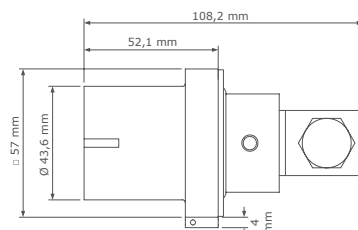

Basic panel source
with ComLug L

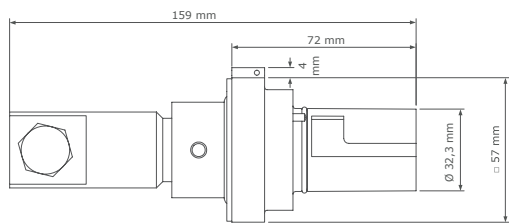

Basic panel drain
with ComLug L2

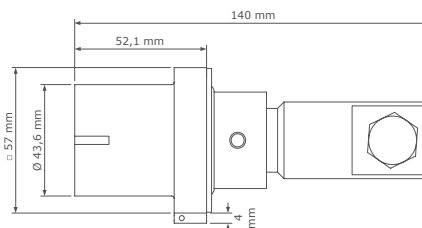

Basic panel source
with ComLug L2

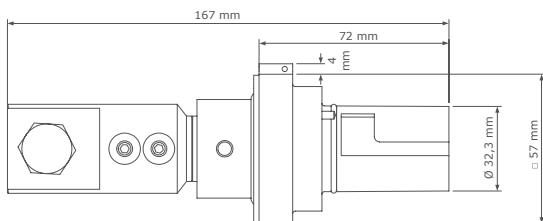

Basic panel drain
with ComLug XL

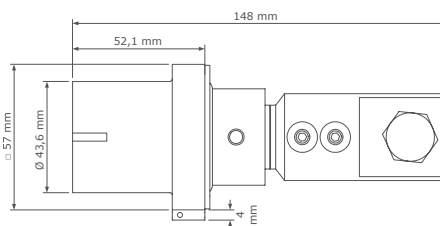

Basic panel source
with ComLug L2

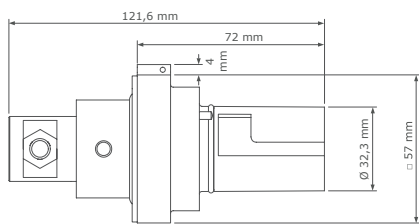

Basic panel drain
with EasiLug

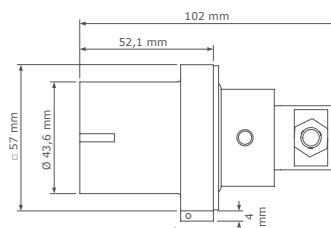

Basic panel source
with EasiLug

Panel mount cut-out dimensions

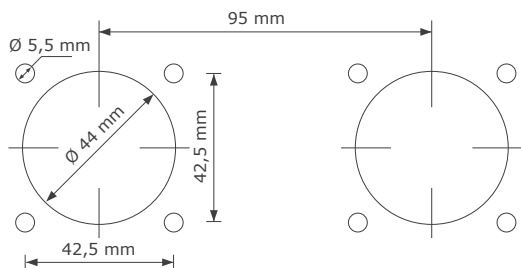

Basic panel drain front mounted

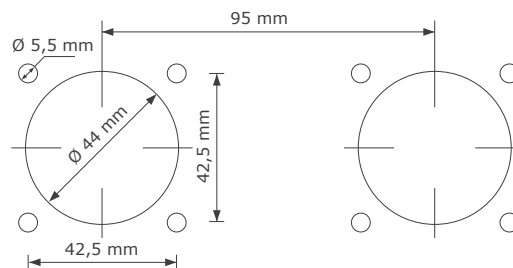

Basic panel source front mounted

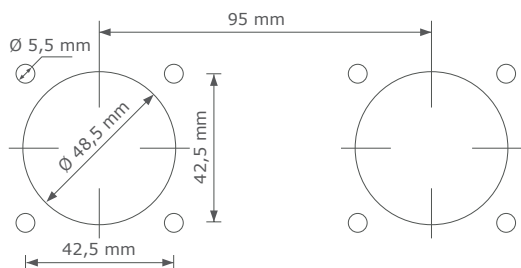

Basic panel drain rear mounted

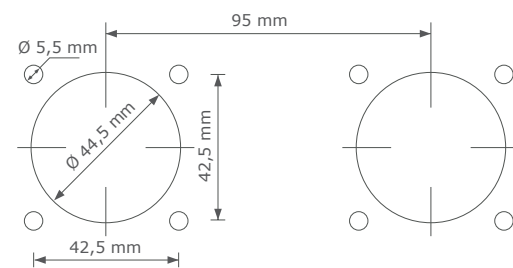

Basic panel source rear mounted

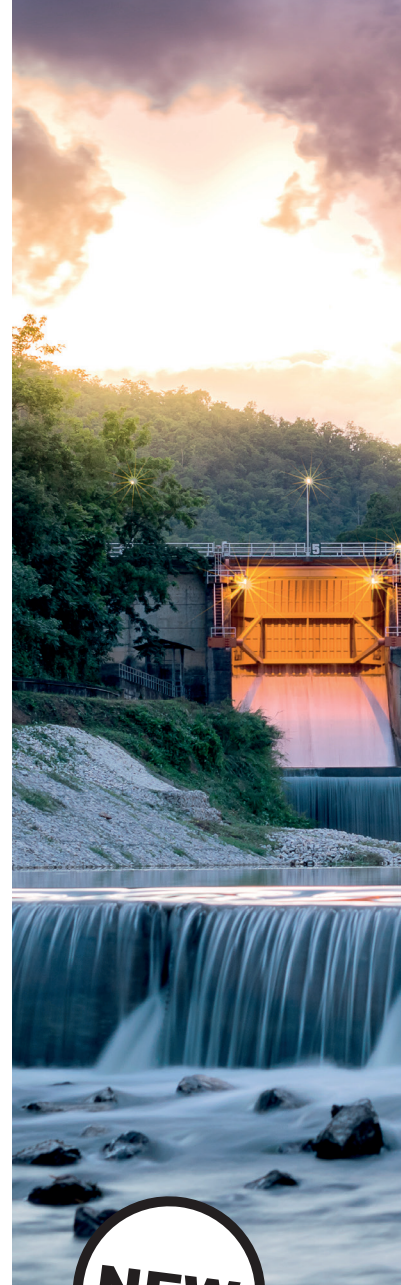

Shelter Evolution

**IP67 Protective backshell add-on
for Basic panel connectors**

Shelter Evolution add-on for panel-mount PowerSyntax Basic connectors provide total insulation and watertight protection on the cable-to-connector joints on the back of your panels. The range features multiple models of thermoplastic insulating flanges and backshells that are machined and designed to perfectly combine with the different PowerSyntax contact types. Every backshell is available with M40 or M50 threads to fit the IP68 gland that better adapts to your cable diameter. This system provides optimal cable strain relief and creates an actual shelter offering a range of ideally-sized mechanically strong solutions for IP67 watertight seal at the cable-to-contact connection.

The ultimate accessory for your insulated panels

Now you can mount a IP67 backshell
on your Basic panel connectors

The Short version of the Shelter Evolution is compatible with PowerSyntax Basic panel connectors with Set-screw or Crimp contact terminals for copper cables. The Medium version is built for Basic connectors carrying bimetal EasiLug contacts, made to be used with PowerSyntax bimetal terminals for aluminium cables, or ComLug L contacts that will be suitable to fit cable lugs commonly available on the market. The Long variant is designed to host our ComLug L2 and XL contacts, for bigger lug-terminated copper cables.

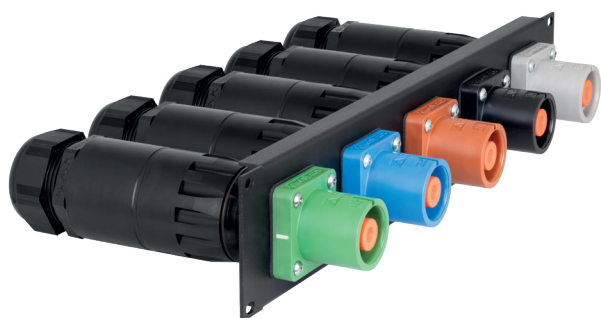

Panel view

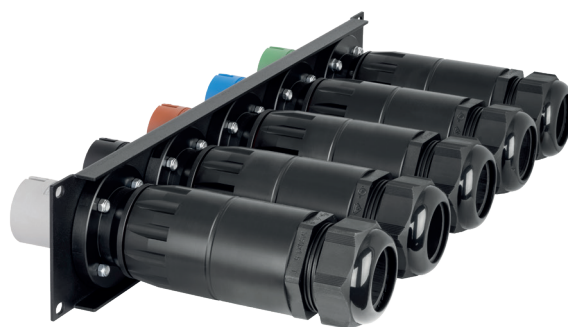

Backshell view

Extreme protection and no mechanical stress on the backshell

This new version of the PowerSyntax Shelter features a special design that allows to distribute most of the cable weight on the panel structure, unburdening the Shelter backshell and providing ideal cable management with the plus of a totally waterproof and electrically insulated solution for the cable-to-connector joints. This accessory is designed to be fitted on the back of Basic connectors, with the choice of a wide range of compatible contacts.

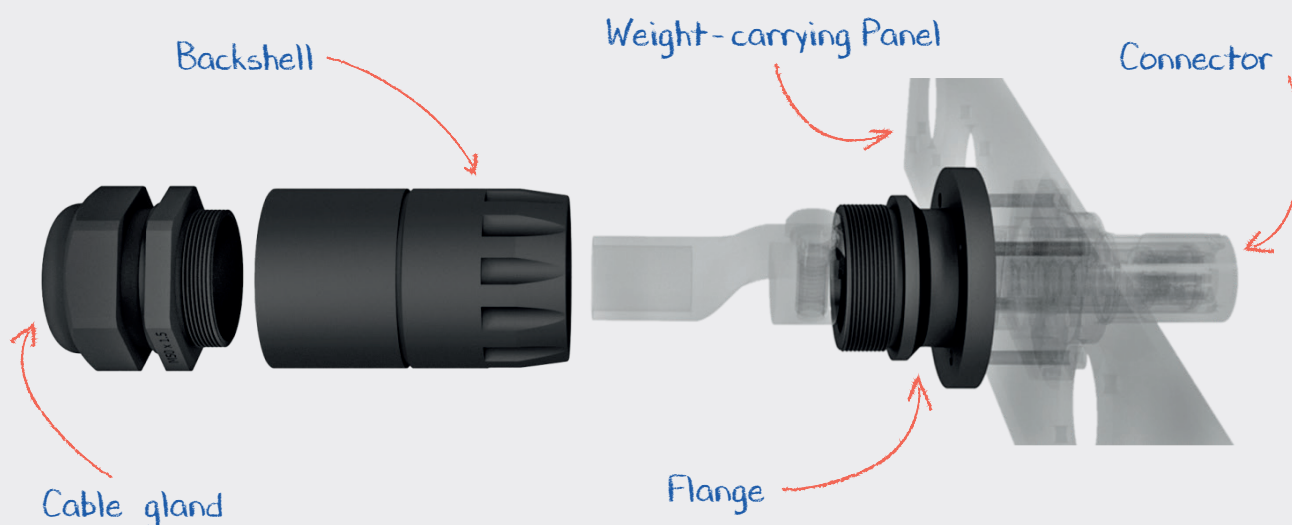

Shelter Evolution - Short version

Available with M40 or M50 cable gland thread



Great safety in little space

The Short version is the smallest of our Shelter Evolution solutions and can be fitted to PowerSyntax Basic panel connectors equipped with Set-screw or Crimp contacts. The Set-screw contacts include a sleeve to retain the cable and are suitable for copper cables up to 150 mm² and for rated current up to 480amp.

When using cables 95 mm² or smaller, they can accommodate an optional sleeve adapter. The Crimp contacts are suitable for cables up to 300 mm² and for currents up to 750amp.

Supported contacts for Short version

Set screw contact

Up to 480 amp. Cable retained through reduction sleeve (25-150 mm²) and set screws suitable reduction sleeve is included. Used as a standard on SPX/SPZ 480 amp line source/drain connectors, the set screw contact is also available for panel connectors on request. Tightening torque 12Nm.

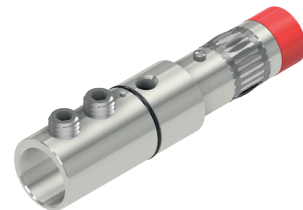

Sleeve adapter system for set screw contacts

The ultimate solution for 25 to 95 mm² cables.

On other connectors on the market, multiple concentric sleeves are used to reduce the cable section from 150 or 120 mm² down to the smaller section specifically needed. The thoughtful design and the mechanical reliability of our sleeve adapter eliminates the need to use multiple concentric sleeves.



Cable section (class 5)	25 mm ²	35 mm ²	50 mm ²	70 mm ²	95 mm ²	120 mm ²	150 mm ²
Recommended sleeve adapter (p/n)	SPX-RED025	SPX-RED035	SPX-RED050	SPX-RED070	SPX-RED095	-	-
Cable strip length	33 mm	33 mm	33 mm	33 mm	33 mm	33 mm	33 mm
Set screw tightening torque	12Nm	12Nm	12Nm	12Nm	12Nm	12Nm	12Nm
M10 hex set screw (2pcs)	allen key size 5	allen key size 5	allen key size 5	allen key size 5	allen key size 5	allen key size 5	allen key size 5



Crimp contact

Crimp contact, up to 750 amp, and up to 300 mm² cable sections. The position and number of cable compressions vary according to the different cable sections.
Cable stripping length is 42 mm.

For all crimping data see the section starting from page 40

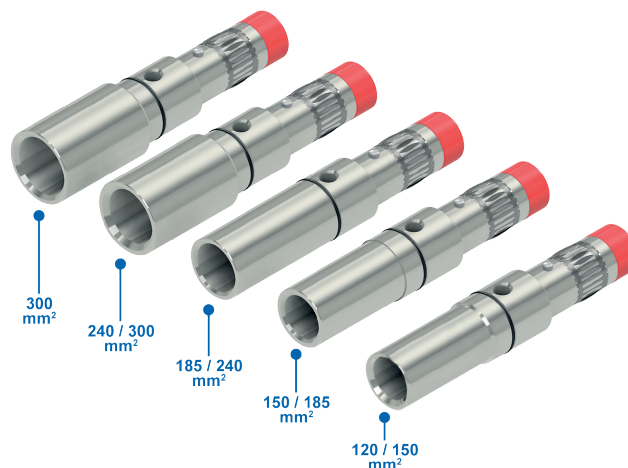

Shelter Evolution - Medium version

Available with M40 or M50 cable gland thread

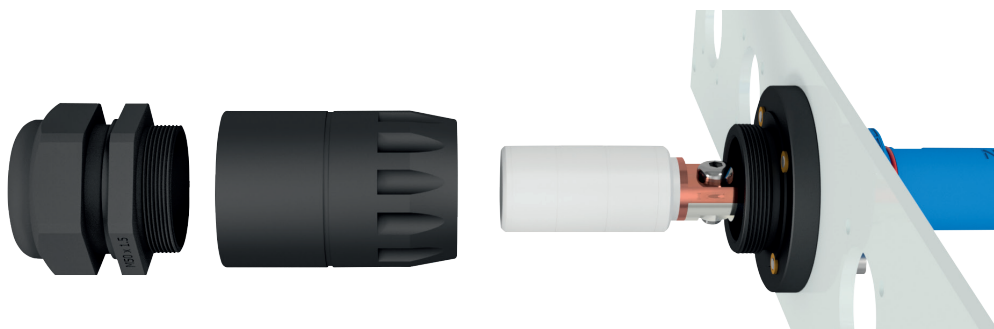

Copper or aluminium? No problem!

The Medium version of the Shelter Evolution is designed to be attached to PowerSyntax Basic panel connectors fitted with ComLug L or EasiLug contacts. The ComLug L can host lug terminals for cables up to 120 mm² (check Lug compatibility chart at page 37). The EasiLug bimetal contact is used in combination with the PowerSyntax bimetal terminal for aluminium cables. Both contacts can carry rated currents up to 480amp.

Supported contacts for Medium version

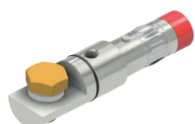

SPY ComLug L

Entirely designed and produced by Syntax, contact up to 480 amp and suitable for cable lug terminals up to 120 mm². Tightening torque 30Nm.

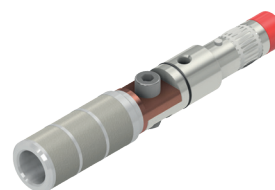

SPY EasiLug - Bimetal

Complete EasiLug contact with bimetal (aluminium/copper) terminal for aluminium cables. Tightening torque 20Nm.

For all crimping data see the section starting from page 40

Knurled brass threaded inserts

For Short and Medium versions

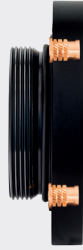

The New Shelter Short and Medium versions are attached to panels through special brass threaded inserts. Their knurled bands on the outside will grip the plastic of the flange element as the screws are tightened into the insert.

Compatible screws: Stainless steel; ISO 7380-1; Metric M5; 3mm Hex socket; Button head screw; Head height 2.75mm; Head diameter 9.5mm. Thread lengths, depending on the thickness of the panel: 30mm (panel thickness 0-5mm) ; 35mm (5-10mm)



Shelter Evolution - Long version

Available with M40 or M50 cable gland thread

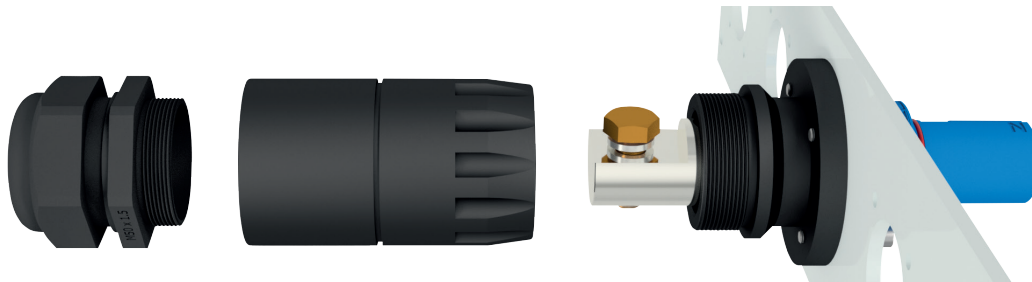

A longer Shelter for bigger lugs

The Long version of the Shelter Evolution is made to work in combination with PowerSyntax Basic panel connectors fitted with ComLug L2 or ComLug XL contacts. The ComLug L2 can host lug terminals for cables up to 240 mm². The ComLug XL contact is used with cables up to 300 mm². Both contacts can carry rated currents up to 750amp. For more information about lugs and cable sizes check the Lug compatibility chart at page 37.

Supported contacts for Long version

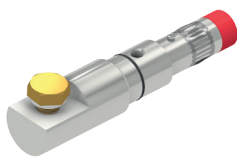

SPY ComLug L2

Entirely designed and produced by Syntax, contact up to 750 amp and suitable for cable lug terminals up to 240 mm². Tightening torque 30Nm.

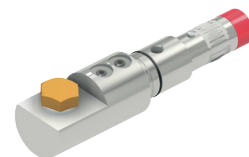

SPY ComLug XL

Entirely designed and produced by Syntax, contact up to 750 amp and suitable for cable lug terminals up to 300 mm². Tightening torque 30Nm.

Versions and Part Numbers

Shelter Evolution only - connector not included

For the connector and Shelter Evolution combination check the Part numbers pages.

Cable Gland	Short version (Compatible with set-screw and crimp contacts)	Medium version (Compatible with EasiLug and ComLug L contacts)	Long version (Compatible with ComLug L2 and ComLug XL contacts)
Shelter with M40 thread and without cable gland	SPXSH-SM4	SPXSH-MM4	SPXSH-LM4
Shelter with M50 thread and without cable gland	SPXSH-SM5	SPXSH-MM5	SPXSH-LM5
Shelter with reduced M40 gland Ø 15-23 mm	SPXSH-SMQ	SPXSH-MMQ	SPXSH-LMQ
Shelter with normal M40 gland Ø 19-28 mm	SPXSH-SMP	SPXSH-MMP	SPXSH-LMP
Shelter with oversized M40 gland Ø 22-32 mm	SPXSH-SMR	SPXSH-MMR	SPXSH-LMR
Shelter with M50 gland Ø 30-38 mm	SPXSH-SMU	SPXSH-MMU	SPXSH-LMU

Overall dimensions

Shelter Evolution

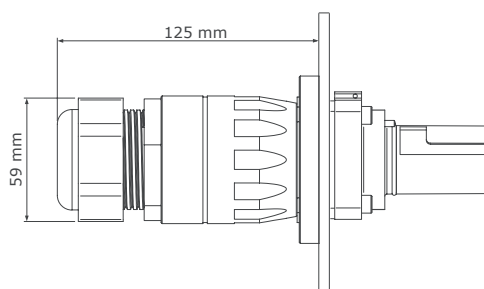

Short version
with M40 gland

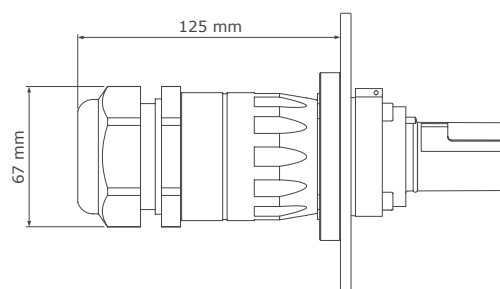

Short version
with M50 gland

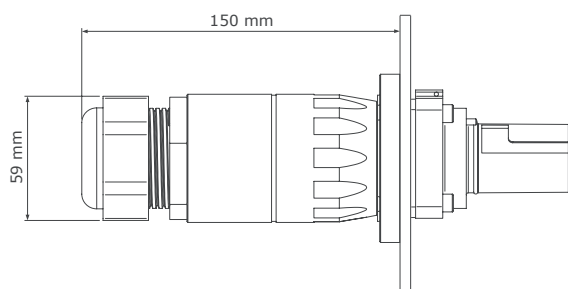

Medium version
with M40 gland

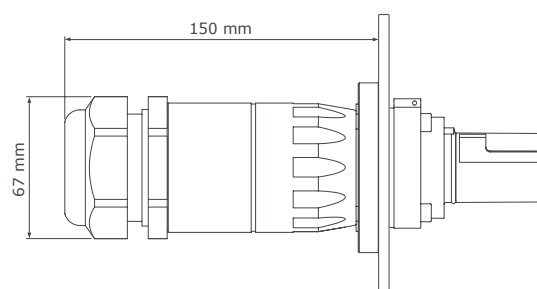

Medium version
with M50 gland

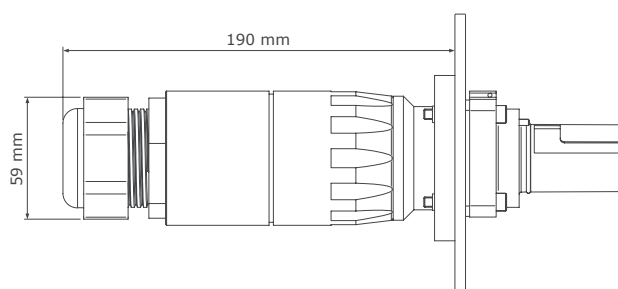

Long version
with M40 gland

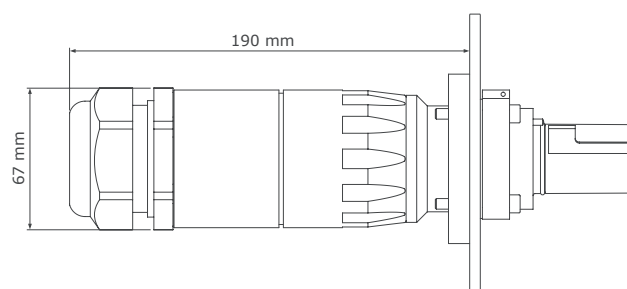

Long version
with M50 gland



PowerSyntax 45 PowerSyntax 90

Single pole 45 or 90 degree
angled panel connectors

PowerSyntax 45 and PowerSyntax 90 are designed to provide space saving options for your operations and a better management of your single pole, Powerlock compatible, panel-mount connections. Thanks to their versatile design they are an ideal combo with our patented Chain Pilot models, with our Basic panel connectors as a further option. PowerSyntax 45 and PowerSyntax 90 are available for current ratings up to 480 amp or 750 amp, Source and Drain versions.

PowerSyntax 45

Drain and Source | 480 or 750 amp

Extra grip on plastic materials thanks to A2 stainless steel screws with pan heads. Knurled brass threaded inserts providing secure fixing to panels. IP2X protection through patented drain contact lock. Secondary locking safety system. Permanent phase identification and safety information markings engraved on connector's body. No stickers applied.



PowerSyntax 90

Drain and Source | 480 or 750 amp

Extra grip on plastic materials thanks to A2 stainless steel screws with pan heads. Knurled brass threaded inserts providing secure fixing to panels. IP2X protection through patented drain contact lock. Secondary locking safety system. Permanent phase identification and safety information markings engraved on connector's body. No stickers applied.



Contacts

for PowerSyntax 45

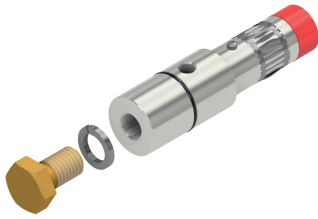

M12 threaded hole

Standard contact for PowerSyntax 45

Up to 480 amp or 750 amp (all copper contact). Lug terminal retained through M12 bolt. Tightening torque 30Nm.

for PowerSyntax 90

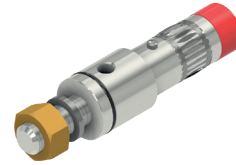

M12 threaded post

Standard contact for PowerSyntax 90

Up to 480 amp or 750 amp (all copper contact). Lug terminal retained through M12 nut. Tightening torque 30Nm.

Essential when mounting PowerSyntax 45 on metal panels

Insulating plastic ring

Being safety always our first priority, we designed an extra protection, necessary when installing our PowerSyntax 45 on metal or conductive panels. This plastic ring, placed on the back of the panel, helps preventing any possible contact between the lug and the panel itself.

Caution: on metal panels the cut-out diameter is 48mm.

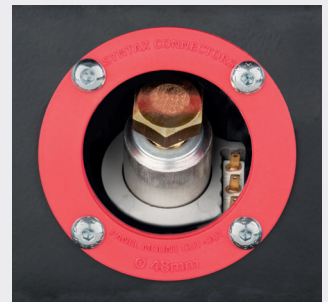

Knurled brass threaded inserts

Providing secure fixing to panels

The PowerSyntax 45 & 90 are attached to panels through special brass threaded inserts. Their knurled bands on the outside will grip the plastic of the base element as the screws are tightened into the insert.



Compatible screws: Stainless steel; ISO 7380-1; Metric M5; 3mm Hex socket; Button head screw; Head height 2.75mm; Head diameter 9.5mm.

Thread lengths, depending on the thickness of the panel: 16mm (panel thickness 0-5mm); 20mm (panel thickness 5-10mm)



Overall dimensions

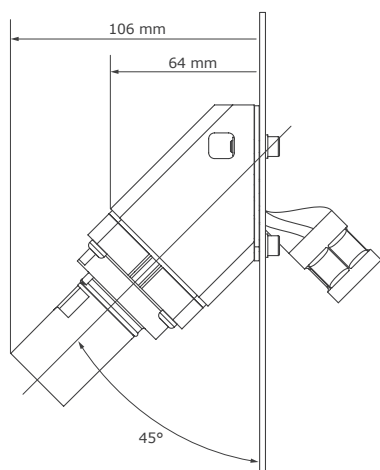

PowerSyntax 45
Panel drain
Side view

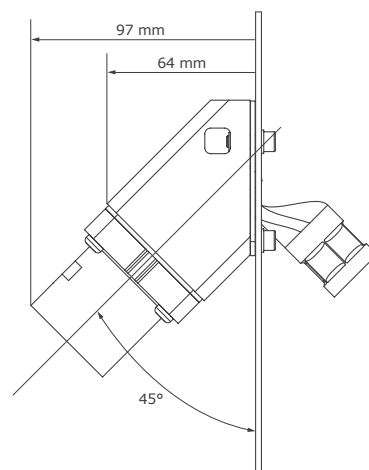

PowerSyntax 45
Panel source
Side view

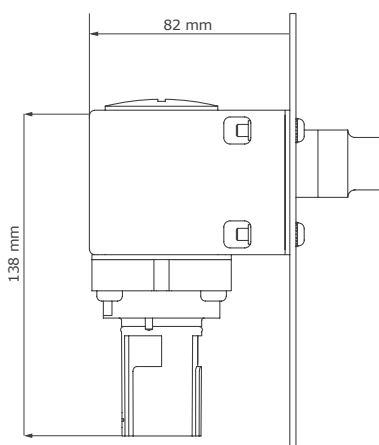

PowerSyntax 90
Panel drain
Side view

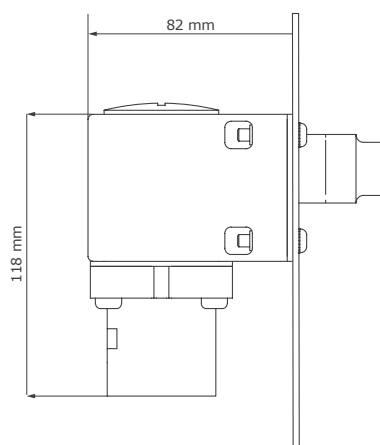

PowerSyntax 90
Panel source
Side view

Panel mount cut-out dimensions

PowerSyntax 45

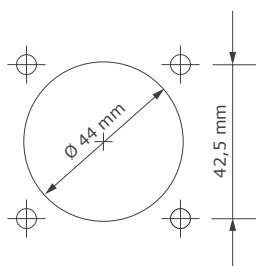

For non-conductive panels
Panel drain/source

PowerSyntax 45

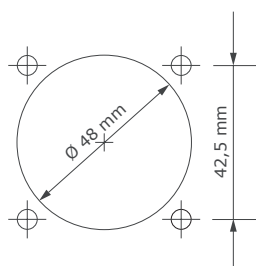

**For metal or conductive panels
and insulating plastic ring**
Panel drain/source

PowerSyntax 90

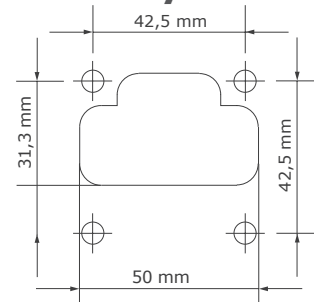

Panel cut-out
Panel drain/source



Line connectors

Line source and Line drain
480 and 750 amp

A full range of high current, Powerlock compatible, single pole connectors for your cables. With 3 different shell versions and 7 contact types, an unprecedented range of combinations is made available for you. No matter the section of your cables, in the PowerSyntax range you are sure to find YOUR ideal solution to manage any sections from 25 to 300 mm². For copper or aluminium cables, with no compromises on connectors' design and performances.

Short body connector

Line drain and line source | 480 amp

Innovative ergonomic hand grip for easy handling. IP2X protection through patented drain contact lock and source finger protection to prevent touching live parts. Contact to housing retention through flame-retardant UL94-VO plastic cotter pin. No special assembling tools needed. Secondary locking safety system. IP68 watertight M40 plastic cable gland for cable strain relief, with 15 - 32 mm clamping range. Permanent phase/line identification and safety information markings embossed on connector's shell. No additional information stickers applied.



Standard body connector

Line drain and line source 480 amp & 750 amp

Innovative ergonomic hand grip for easy handling. IP2X protection through patented drain contact lock and source finger protection to prevent touching live parts. Contact to housing retention through flame-retardant UL94-VO plastic cotter pin. No special assembling tools needed. Secondary locking safety system. IP68 plastic cable gland for cable strain relief, with 15 - 32 mm (M40) or 30 - 38 mm (M50) clamping range. Permanent phase/line identification and safety information markings embossed on connector's shell. No additional information stickers applied.



Oversized body connector

Line drain and line source | 750 amp

Extra large body cavity, ideal when using lug terminals for big cable sections. Improved hand grip for easy handling. IP2X protection through patented drain contact lock and source finger protection to prevent touching live parts. Contact to housing retention through flame-retardant UL94-VO plastic cotter pin. No special assembling tools needed. Secondary locking safety system. IP68 plastic cable gland for cable strain relief, with 30 - 38 mm (M50) clamping range. Permanent phase/line identification and safety information markings embossed on connector's shell. No additional information stickers applied.



Contacts

and cable retention types for line connectors

The PowerSyntax connectors are equipped with different contact types, depending on current rating (480 amp or 750 amp), cable material (aluminum or copper), connectors body type (line or panel-mount) and cable terminations.

Solutions for copper cables



Set screw contact

Up to 480 amp. Cable retained through reduction sleeve (25-150 mm²) and set screws suitable reduction sleeve is included. Used as a standard on SPX/SPZ 480 amp line source/drain connectors, the set screw contact is also available for panel-mount connectors on request. Tightening torque 12Nm.

Sleeve adapter system

for set screw contacts

The ultimate solution for 25 to 95 mm² cables.

On other connectors on the market, multiple concentric sleeves are used to reduce the cable section from 150 or 120 mm² down to the smaller section specifically needed. The thoughtful design and the mechanical reliability of the our sleeve adapter eliminates the need to use multiple concentric sleeves.

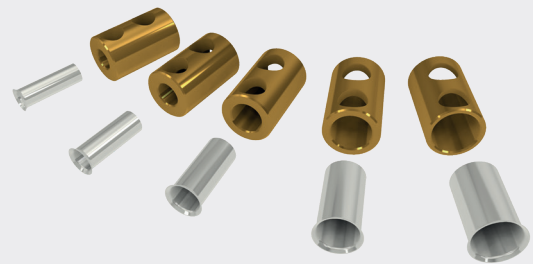

Cable section (class 5)	25 mm ²	35 mm ²	50 mm ²	70 mm ²	95 mm ²	120 mm ²	150 mm ²
Recommended sleeve adapter (p/n)	SPX-RED025	SPX-RED035	SPX-RED050	SPX-RED070	SPX-RED095	-	-
Cable strip length	33 mm	33 mm	33 mm	33 mm	33 mm	33 mm	33 mm
Set screw tightening torque	12Nm	12Nm	12Nm	12Nm	12Nm	12Nm	12Nm
M10 hex set screw (2pcs)	allen key size 5	allen key size 5	allen key size 5	allen key size 5	allen key size 5	allen key size 5	allen key size 5



Crimp contact for standard body connector

Crimp contacts, up to 750 amp, and up to up to 300 mm² cable sections. The position and number of cable compressions will vary according to the different cable sections. Cable stripping length is 42 mm.

For all crimping data see the section starting from page 40

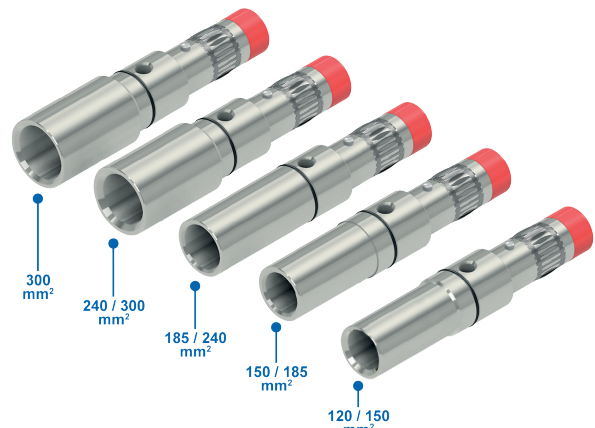

Lug converters for copper cables terminated with common lugs

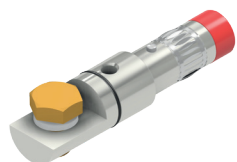

SPY ComLug L
Lug Converter



For standard body connector

Entirely designed and produced by Syntax, contact up to 480 amp and suitable for cable lug terminals up to 120 mm². Tightening torque 30Nm.

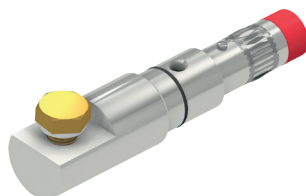

SPY ComLug L2
Lug Converter



For oversized body connector

Entirely designed and produced by Syntax, contact up to 750 amp and suitable for cable lug terminals up to 240 mm². Tightening torque 30Nm.

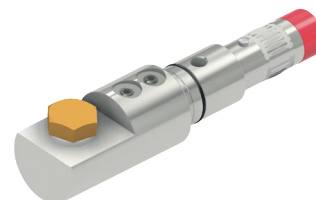

SPY ComLug XL
Lug Converter



For oversized body connector

Entirely designed and produced by Syntax, contact up to 750 amp and suitable for cable lug terminals up to 300 mm². Tightening torque 30Nm.

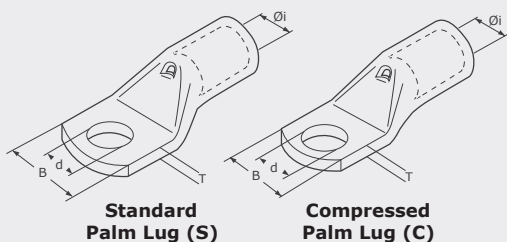

Lug Type	B	Cable section (flex)	Øi	d Ø screw	T	Contact
S	25,0	70 - 95 mm ²	13,5	12 mm	5 mm max	L - L2 - XL
S	28,5	95 - 120 mm ²	15,2	12 mm	5 mm max	L - L2 - XL
S	31,5	120 - 150 mm ²	16,7	12 mm	5 mm max	L2 - XL
S	35,5	150 - 185 mm ²	19,2	12 mm	5 mm max	L2 - XL
C	31,0	240 mm ²	21,1	12 mm	5 mm max	L2 - XL
C	31,0	300 mm ²	23,7	12 mm	5 mm max	XL

Solutions for aluminium cables for currents up to 480 amp

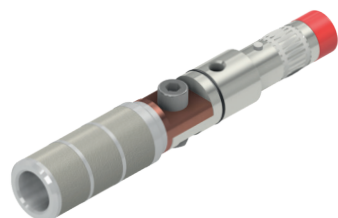

SPY EasiLug - Bimetal

Complete EasiLug contact with bi-metal (aluminium/copper terminal) for aluminium cable. Used as a standard on SPY EasiLug connectors for aluminium cables, this contact type is also available for panel-mount connectors on request. Tightening torque 20Nm.

For all crimping data see the section starting from page 40

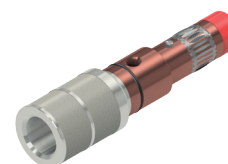

SPV - Bimetal

Bimetal (aluminium/copper) crimp contact for up to 300 mm² cable sections. Designed to be used in combination with aluminium cables.

For all crimping data see the section starting from page 40

Overall dimensions

Line version



Short body

Line drain | Actual product

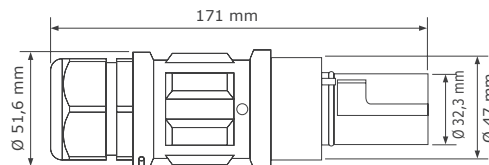

Short body

Line drain | Dimensions



Short body

Line source | Actual product

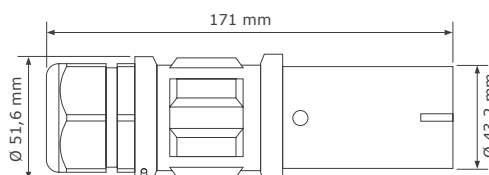

Short body

Line source | Dimensions



Standard body

Line drain | Actual product

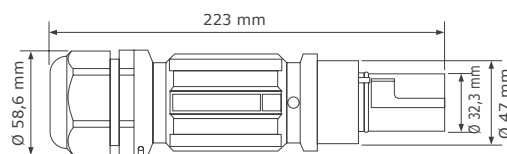

Standard body

Line drain | Dimensions



Standard body

Line source | Actual product

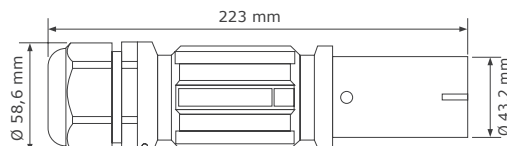

Standard body

Line source | Dimensions



Oversized body

Line drain | Actual product

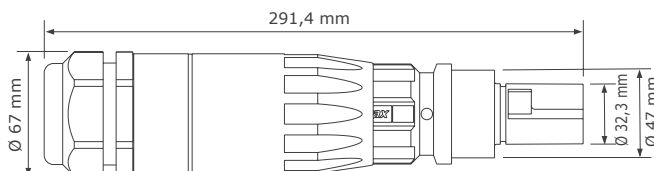

Oversized body

Line drain | Dimensions



Oversized body

Line source | Actual product

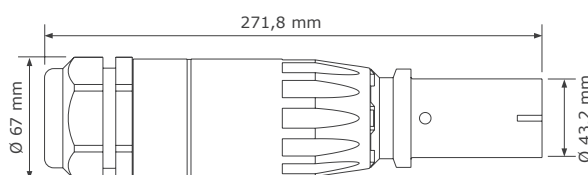

Oversized body

Line source | Dimensions

Machined adaptors

for PowerSyntax line connectors

Adaptors and extensions thoughtfully designed and built to widen the clamping range options of your PowerSyntax connectors.



Extra quality in every detail

Our accessories are state of the art not only in terms of design but also for the properties of the material employed. The Acetal resin, commonly known as POM-C, is characterized by high mechanical strength, stiffness, heat resistance, good antifriction properties, low moist absorption and high resistance to a wide range of chemicals, including many solvents. Every piece is individually machined from a single block of solid plastic.

M40 to M50 adaptor

for PowerSyntax connectors
and M50 cable glands

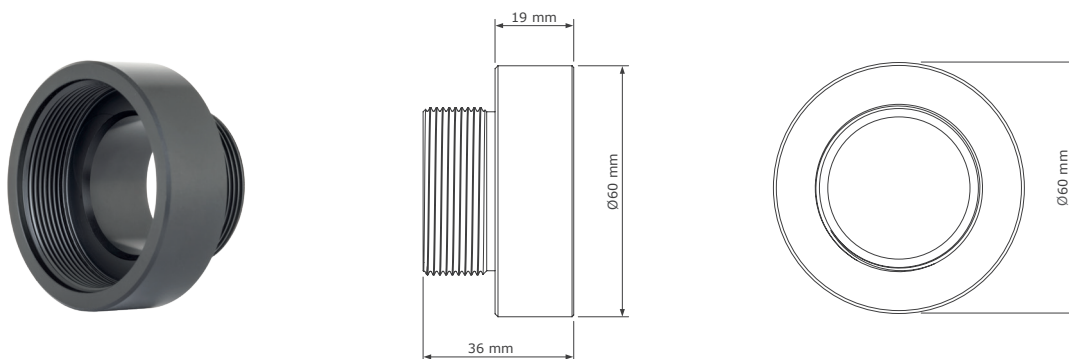

M40 to M40 backshell extension

for Standard body connectors
with EasiLug contacts

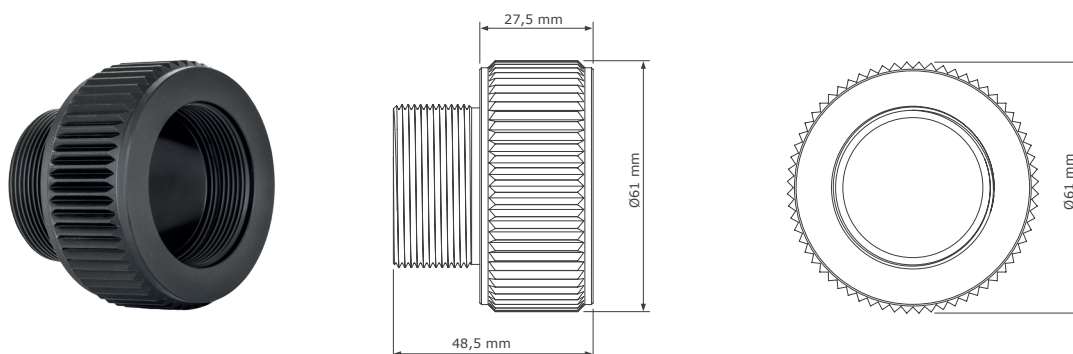

Crimping data and cable stripping

On crimp contacts (up to 750 amp copper / 480 amp bimetal, and up to up to 300 mm² cable sections), the position and number of cable compressions will vary according to the different cable sections (see tables below).

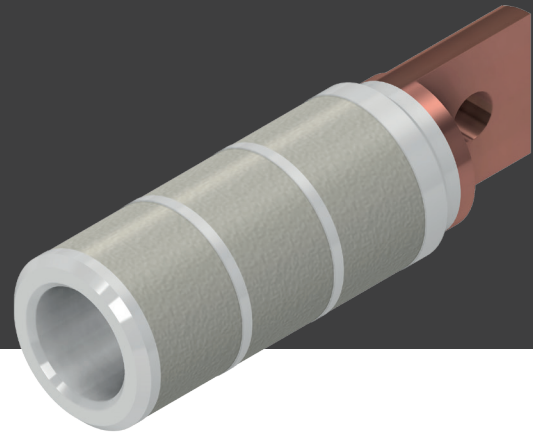

Aluminium cables - SPY EasiLug

Class 5

Lug model	120 mm ²	150 mm ²	185 mm ²	240 mm ²	300 mm ²
Contact internal Ø	15 mm	16,5 mm	18,5 mm	21,3 mm	23,3 mm
Cable strip length (L)	60 mm	60 mm	60 mm	60 mm	60 mm
No. of crimpings	3	3	3	3	3
Crimping width	14 mm	14 mm	14 mm	14 mm	14 mm
Crimp die set p/n	SBH-CRIMP-120AL	SBH-CRIMP-150AL	SBH-CRIMP-185AL	SBH-CRIMP-240AL	SBH-CRIMP-300AL

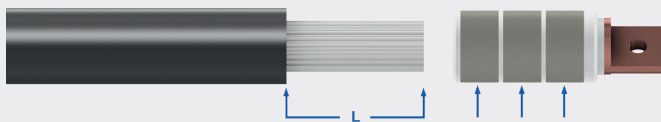
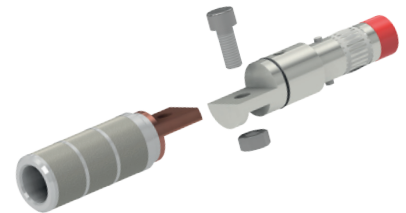

Crimp in the middle of each crimping area, inside the guides.

Aluminium cables - SPV

Class 5

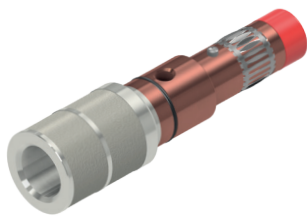

Lug model	120 mm ²	150 mm ²	185 mm ²	240 mm ²	300 mm ²
Contact internal Ø	15 mm	16,5 mm	18,5 mm	21,3 mm	23,3 mm
Cable strip length (L)	42 mm	42 mm	42 mm	42 mm	42 mm
No. of crimpings	2	2	2	2	2
Crimping width	14 mm	14 mm	14 mm	14 mm	14 mm
Crimp die set p/n	SBH-CRIMP-120AL	SBH-CRIMP-150AL	SBH-CRIMP-185AL	SBH-CRIMP-240AL	SBH-CRIMP-300AL

Crimp in the middle of each crimping area, inside the guides.

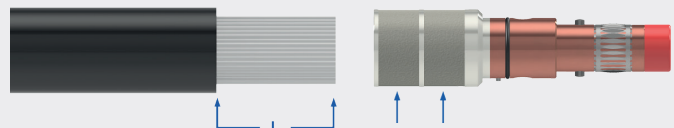

Copper cables - SPX

Class 5

Contact model source/drain	120/150 mm ²	150/185 mm ²	185/240 mm ²	240/300 mm ²	300 mm ²
Contact internal Ø	16,5 mm	17,9 mm	19,7 mm	22,2 mm	23,7 mm
Cable strip length (L)	42 mm	42 mm	42 mm	42 mm	42 mm
No. of crimpings	2	2	2	3	3
Crimping width	14 mm	14 mm	14 mm	7 mm	7 mm
Crimp die set p/n	SBH-CRIMP-120/150RM	SBH-CRIMP-185/240RM	SBH-CRIMP-185/240RM	SBH-CRIMP-240/300RM	SBH-CRIMP-240/300RM

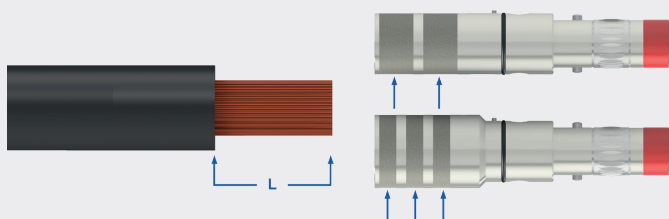

Crimp in the middle of each crimping area, inside the guides.

Hydraulic crimp tool

Hand operated or cordless



Hand operated hydraulic crimp tool

Part No. **SBH-CRIMP-B**



Cordless hydraulic crimp tool

Part No. **SBH-CRIMP-C**



300 mm²

240 mm²

185 mm²



150 mm²

120 mm²

Aluminium

Crimp die set for hydraulic crimp tools

For corresponding part numbers see the table in the previous page



240/300 mm²

185/240 mm²



185/150 mm²

150/120 mm²

Copper

Crimp die set for hydraulic crimp tools

For corresponding part numbers see the table above.



NEW

Vertical PowerSyntax

Single pole 90 degree angled cable connector

Finally a PowerSyntax 90 degrees angled single pole cable connector, designed and built with great attention to every detail, like we always do. Every piece is carefully machined in our mechanical workshop, to ensure the maximum reliability and safety for the operator. Vertical PowerSyntax is built to carry currents up to 480 or 750 amp. Available in source and drain versions and in all regional conductor/color combinations.

Bending the rules of connection

The easiest way to save space

A new way to imagine single pole cable connectors, the new Vertical PowerSyntax is the ideal solution when space saving is key. Vertical is a right-angled cable connector, fitted with a M12 threaded hole contact for currents up to 480 or 750 amp.

IP2X protection through patented drain contact lock. Secondary locking safety system. M40 cable glands, available with 3 different clamping range options. Permanent phase identification and safety information markings engraved on connector's body. No stickers applied. Drain and Source versions available.

Contact us for more information and ordering details.



Line drain

Vertical PowerSyntax
480 | 750 amp



Line source

Vertical PowerSyntax
480 | 750 amp



Overall dimensions

Vertical PowerSyntax

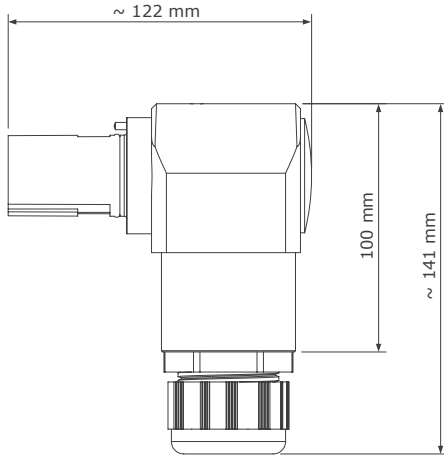

Vertical PowerSyntax
Line drain | Dimensions
Side view

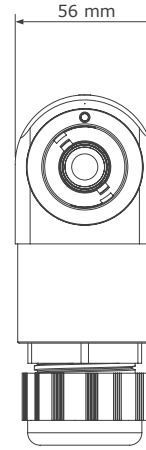

Vertical PowerSyntax
Line drain | Dimensions
Front view

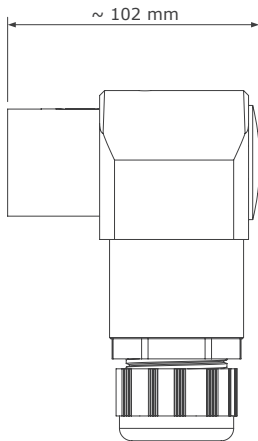

Vertical PowerSyntax
Line source | Dimensions
Side view

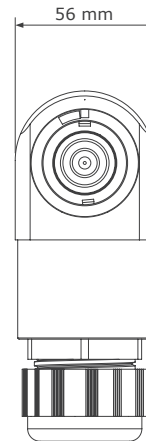

Vertical PowerSyntax
Line source | Dimensions
Front view

Contact

for Vertical PowerSyntax

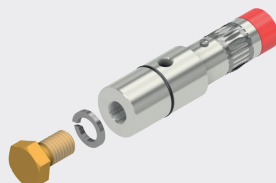

M10 threaded hole

Standard contact

Up to 750 amp, all copper contact.
Lug terminal retained through M10 bolt.

Cable protection and management

Wire mesh strain reliefs, hanger grips and pulling grips

Explore our full range of wire mesh solutions designed to be fitted on cables or directly on PowerSyntax connectors for optimal cable management, increased protection and longer life span.



The right technology for long-lasting connections

Discover our cable management solutions

The quality of a connection depends on many factors. Reliable connectors are essential, of course, and the cables are a top priority too. Choosign high quality products made with the best materials is important, but there are other parts of the job that should not be overlooked. How you lay a cable, how you protect it from unwanted stresses, how you make sure it will be safeguarded from external elements that might possibly damage your connections over time, these decisions are all integral to achieve highly reliable connections.

Our accessories are thoughtfully designed and manufactured for ideal cable management, handling and protection.

Please contact us for more information about our cable management accessories.



Strain Reliefs

Thoughtfully designed to reduce tension on cables and, therefore, stress related damages to your connections due to excessive bending. Available in a wide range of thread sizes and overall diameters to fit any connector and cable combinations.

Hanger grips

Heavy duty wire mesh hangers are designed to ensure optimal support and right retention of the cable without any sliding or scraping of the external jacket. Different styles and sizes are available in stock for any kind of application, both indoors or outdoors.

Pulling grips

Created to provide the operators an efficient way to pull cables through ducts or other spaces in the safest possible way. Made to be extremely resistant and conveniently reusable, and fit to a large number of applications. Different models available.



Premium Power Cables

Assembled by our specialists
Ready to use right aways

Pre-made cable extension with all the reliability of PowerSyntax connectors, only the best cables for great performances and the unmatched comfort of our pulling grips, supplied as standard with each cable. A ready-made solution, in compliance with the international safety regulation.

Choose directly from our stock

Available lengths: 5-10-20-30-50 m

Choose phase/conductor and color

A couple of PowerSyntax line connectors, standard body, drain and source, for currents up to 480 amp. Heavy-duty extra flexible H07RN-F rubber cable with conductive 120mm² single copper core, rubber insulation and neoprene sheath. Oil-resistant and flame-retardant. Every cable is provided with 2x transparent heat shrink for additional marking at customer's care. 5 m cables are provided with 1 pulling grip (drain connector's side). 10, 20, 30, 50 m cables are provided with 2 pulling grips (1 at each connector's side).



Do you need a different combination?

Let's shape your Premium Power Cable together!

Perhaps you couldn't find your ideal extension cable version in our stock? Maybe you need a different phase/color or cable length? Please contact us as our specialists are ready to build it for you.

Example p/n - EU color coding

Length	Ground	Neutral	Line 1	Line 2	Line 3	All phases (5 cables)
05 m	SPXE05GN	SPXN05BL	SPX105BR	SPX205BK	SPX305GY	SPX505EU
10 m	SPXE10GN	SPXN10BL	SPX110BR	SPX210BK	SPX310GY	SPX510EU
20 m	SPXE20GN	SPXN20BL	SPX120BR	SPX220BK	SPX320GY	SPX520EU
30 m	SPXE30GN	SPXN30BL	SPX130BR	SPX230BK	SPX330GY	SPX530EU
50 m	SPXE50GN	SPXN50BL	SPX150BR	SPX250BK	SPX350GY	SPX550EU

Used to dragging your cables by pulling the connector? Forget it!

Our PowerSyntax Line connectors are so ergonomic, we know. But using them to pull the cable can be dangerous. That's why our heavy duty pulling grips are always included, for you to comfortably pull the cable from the handle and not from the connector. This prevents damaging cable-to-connector joints and guarantees maximum safety for the operators.

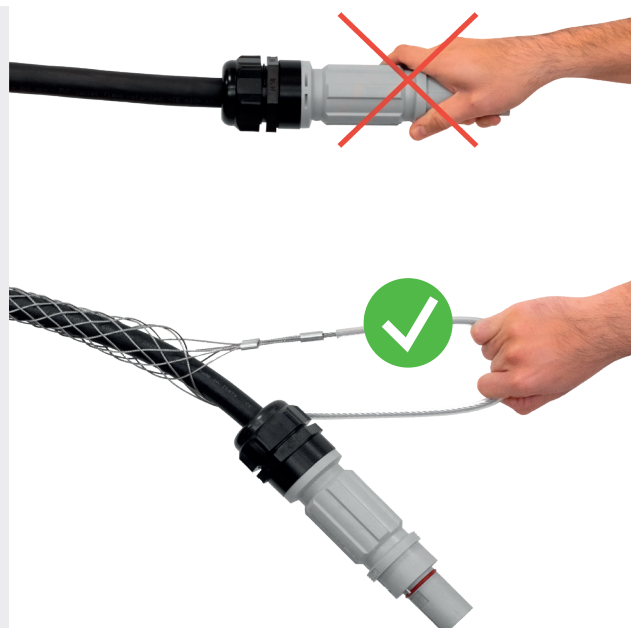

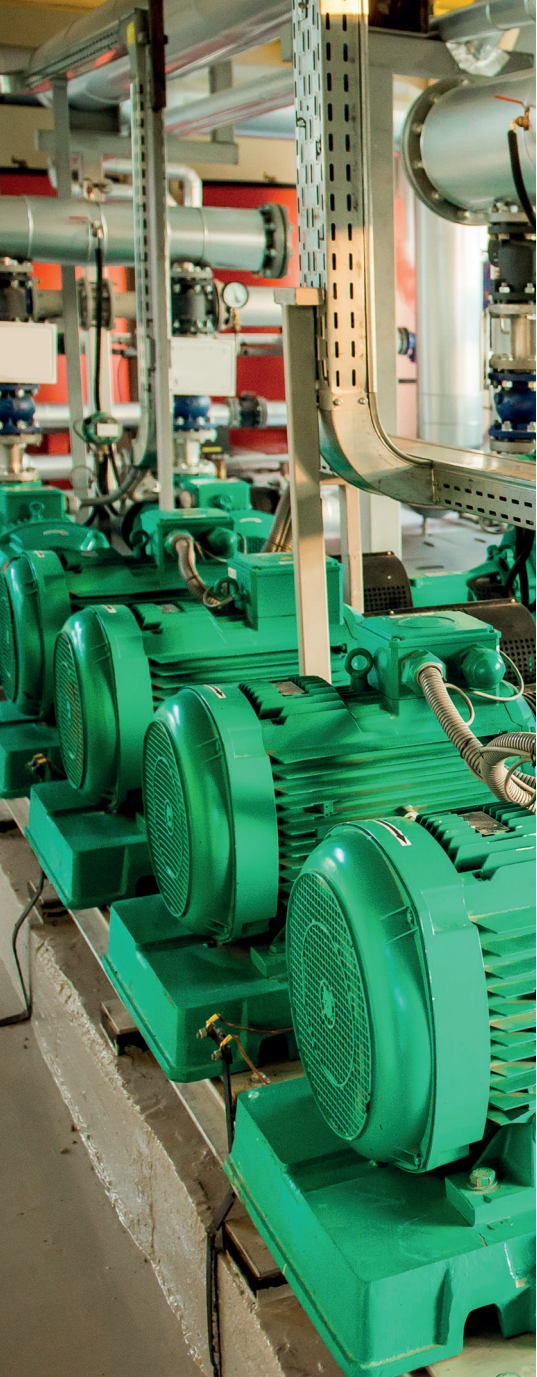

Phase Inverters / Adaptors

Fast, safe and reliable reversal
of two phase conductors.

Discover the whole range of PowerSyntax Inverters/Adaptors, available for currents up to 480 or up to 750 amp and in every combination of phases and regional color coding. Check the tables in the next page and compose the part number of the model you need.

Say goodbye to uncomfortable last minute adaptors on cable

The PowerSyntax® Phase Inverters/Adaptors, available for electric currents up to 480 amp and now also up to 750 amp, have been designed to solve two specific problems: first, reverse the rotation direction in three phase motors by changing the phase sequence (L1-L2-L3) between the power source and the connected devices; second, provide those who use only one model of phase conductor (L1, L2 or L3) to operate L1-L2-L3+Neutral systems with an interface between standard 3-phase power generators and distros and their devices. The former is a common demand in industrial applications. The latter is a specific need of entertainment and cinema industries.



480 amp available version and p/n

Drain	EU	UK	AU	US	Source	EU	UK	AU	US	Part Number
L1	BR	RD	RD	BK	L2	BK	YE	WH	RD	SPZ4LD1__ - LS2__
L1	BR	RD	RD	BK	L3	GY	BL	BL	BL	SPZ4LD1__ - LS3__
L2	BK	YE	WH	RD	L1	BR	RD	RD	BK	SPZ4LD2__ - LS1__
L2	BK	YE	WH	RD	L3	GY	BL	BL	BL	SPZ4LD2__ - LS3__
L3	GY	BL	BL	BL	L1	BR	RD	RD	BK	SPZ4LD3__ - LS1__
L3	GY	BL	BL	BL	L2	BK	YE	WH	RD	SPZ4LD3__ - LS2__



750 amp available version and p/n

Drain	EU	UK	AU	US	Source	EU	UK	AU	US	Part Number
L1	BR	RD	RD	BK	L2	BK	YE	WH	RD	SPZ7LD1__ - LS2__
L1	BR	RD	RD	BK	L3	GY	BL	BL	BL	SPZ7LD1__ - LS3__
L2	BK	YE	WH	RD	L1	BR	RD	RD	BK	SPZ7LD2__ - LS1__
L2	BK	YE	WH	RD	L3	GY	BL	BL	BL	SPZ7LD2__ - LS3__
L3	GY	BL	BL	BL	L1	BR	RD	RD	BK	SPZ7LD3__ - LS1__
L3	GY	BL	BL	BL	L2	BK	YE	WH	RD	SPZ7LD3__ - LS2__



Compose the part number of the model you need by inserting the 2-letter color codes in the blanks in the tables above.



PowerSyntax S2W 480 amp

Multiplier | Adaptor | Phase inverter

Available with EU, UK, AUS and USA color coding.
A complete range of PowerSyntax multipliers, adaptors and phase inverters for currents up to 480 amp, available in standard or reverse versions and with multiple color coding options.



S2W 480 amp multiplier

S2W with 1 drain input and 2 source outputs PowerSyntax 480 amp connectors. Available with EU, UK, AUS and USA color coding. Standard and reverse versions are available. On the reverse version, the input is inline with one of the outputs.

Example p/n - EU color coding

1 input male	color	2 output female	color	Part Number
Line 1		Line 1		S2WX111000S
Line 2		Line 2		S2WX222000S
Line 3		Line 3		S2WX333000S
Neutral		Neutral		S2WXNNN000S
Ground		Ground		S2WXGGG000S

Notice:

- for the reverse version replace final "S" by "R" in the Part Number
- for the version with safety lacing add "-L" at the end of the Part Number
- IP67 or IP53 protection caps available on request.

Typical applications

- All temporary electrical systems
- Power distribution
- Outdoor concerts and sports events
- Outdoor broadcasting
- Theaters, studios and film sets
- Mobile generators
- Industrial vehicles
- Railway and military installations
- Load banks
- Back-up power systems

S2W 480 amp phase inverters/adaptors

The PowerSyntax Phase Inverters/Adaptors have been designed to solve two specific problems: first, reverse the rotation direction in 3-phase motors, etc. by changing the phase sequence (L1-L2-L3) between the power source and the connected devices, a common demand in industrial applications; second, provide those who use only one model of phase conductor (L1, L2 or L3) to operate L1-L2-L3+Neutral systems with an interface between standard three-phase power generators/distros and their devices a typical need in the entertainment industry. Standard and reverse versions are available. On the reverse version, the input is inline with one of the outputs.

Example p/n - EU color coding

1 input male	color	2 output female	color	Part Number
Line 1		Line 3		S2WX133000S
Line 2		Line 3		S2WX233000S
Line 3		Line 2		S2WX322000S
Line 1		Line 2		S2WX122000S
Line 2		Line 1		S2WX211000S
Line 3		Line 1		S2WX311000S

Notice:

- for the reverse version replace final "S" by "R" in the Part Number
- for the version with safety lacing add "-L" at the end of the Part Number
- IP67 or IP53 protection caps available on request.



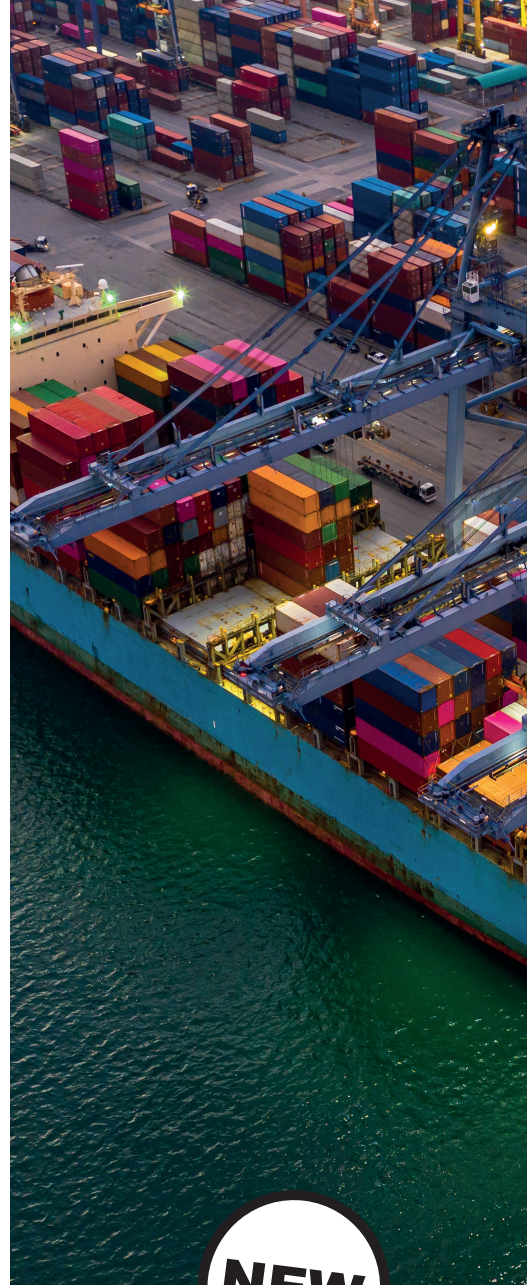

NEW



InsuLugger

Smart and safe protective **IP68** joint for lug terminated power cables

InsuLugger is designed to create an incredibly steady, weatherproof single pole connection, and to make it last for all the time you need. To make its shells, we chose a plastic material with unique qualities: the Acetal resin, commonly known as POM-C and characterized by high mechanical strength, stiffness, heat resistance and good antifriction properties. InsuLugger provides total protection against dust, and is IP68 rated to withstand permanent immersion in water. To avoid improper tampering with connections, our R&D department studied a new safety measure, a blocking screw that the operator has to loosen in order to be able to release the secondary locking system.



InsuLugger Wide

Suitable for 240 and 300 mm² cables

Part number: **SPL-WIDE-MU**

Cable gland: M50 Oversize - Clamping range 30-38mm

Characteristics

Mechanically, thermally, electrically impressive **resin** with a great resistance to water.

IP68 rated: total protection against dust and safe permanent immersion.

Secondary locking system with dedicated ergonomic release key, that allows a safe and convenient way to access the lugs joint core.

Blocking screw that the operator has to loosen in order to be able to release the secondary locking system.

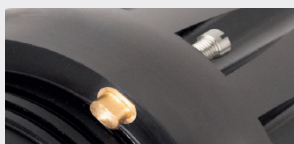

Practical set of **color coded disks** to recognize your connection's phase.



InsuLugger Slim

Suitable for 120, 150 & 185 mm² cables

Part number: **SPL-SLIM-MQ**

Cable gland: M40 Reduced - Clamping range 15-23mm

Part number: **SPL-SLIM-MP**

Cable gland: M40 Normal - Clamping range 19-28mm

Part number: **SPL-SLIM-MR**

Cable gland: M40 Oversize - Clamping range 22-32mm

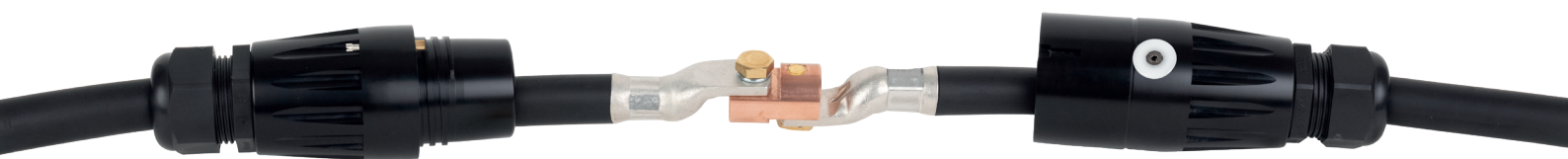

Overall dimensions

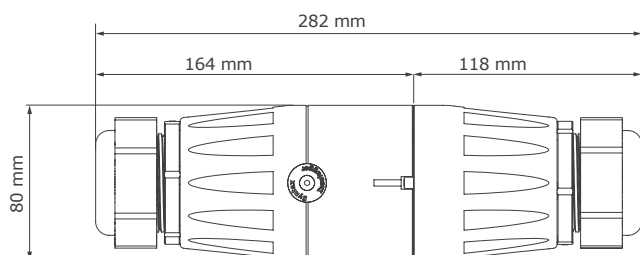

InsuLugger Wide

Side view

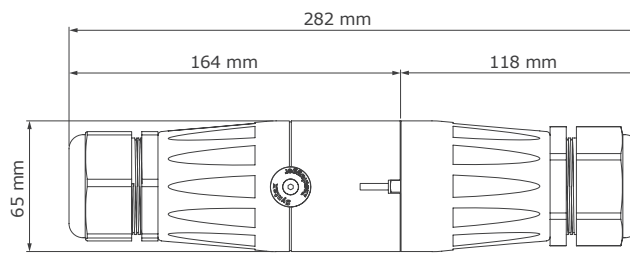

InsuLugger Slim

Side view



SyntaxLock

Release system

Forgot to take some release keys with you before heading to work? Now you can unlock your connectors with SyntaxLock. A simple, universal accessory, quick and easy to install, suitable for all PowerSyntax connectors. SyntaxLock can be fitted or removed at any time.

Now you are free to forget the keys

SyntaxLock is a proprietary release system for the secondary lock on PowerSyntax connectors and IP67 protection caps. A simple yet powerful add-on to your connectors, SyntaxLock combines faster, more practical unlocking with complete safety. In fact it is very easy to install and to use but, in full compliance with the international electrical regulations, unmating still needs a voluntary operation on the key. SyntaxLock is supplied as a separate accessory and can be used for the retrofit of all PowerSyntax connectors built as of 2011.

CAUTION: SyntaxLock must be operated only by qualified technicians in safe and controlled work environments. Do not uncouple under load.



Aiming to the future with an eye on the past

Upgrade the equipment you already own. SyntaxLock is provided as a separate kit and can be used to retrofit every source connector, line or panel, or every IP67 protection cap produced by Syntax since 2011. There is no need to change your equipment to enjoy the improved ease of use of SyntaxLock, just install it on your own PowerSyntax connectors or IP67 protection caps.

A kit for every need

The SyntaxLock is supplied as a universal kit to be fitted on line source or panel source connectors and on IP67 protection caps for drain line and panel connectors. The kit consists of a universal collar, one release key for a panel source connector, one release key for either a line source connector or a IP67 protection cap for drain connectors, one nut and bolt set.

Part Number: **SPX-SYLOCK**



Panel
SyntaxLock
for panel source



Line
SyntaxLock
for line source



Caps
SyntaxLock
with IP67 protection caps

Tightening torque

The torque applied when tightening the SyntaxLock screw must be between **0.10 Nm and 0.15 Nm**.





Protection caps

IP67 and IP53 versions available

A full range of protective covers to prevent damages when your connectors are unmated. PowerSyntax IP67 caps ensure complete waterproof protection while IP53 caps are a fast and easy way to protect connectors.

IP67 Protection caps

The PowerSyntax IP67 caps ensure complete waterproof protection

The PowerSyntax caps are universally keyed to be fitted on any connector's phase, so that just one cap version is needed respectively for Source and Drain connectors resulting in easier management and lower investment through reduced stock assortment. For full safety, the PowerSyntax IP67 caps feature the secondary locking system. The secondary lock will be released using SyntaxLock or a standard release key.



IP67 protective cover for drain
with special housing on caps for lacing
Part Number: **SPXDCC-SC-IP67**



IP67 protective cover for source
with special housing on caps for lacing
Part Number: **SPXDCCS-SC-IP67**

Protection caps lacing

On the PowerSyntax caps, all details have been designed with a strong focus on resistance and reliability. A specific housing for the cap's lacing has been moulded directly on the flange of the panel-mount versions and on the body of the inline versions. The caps are laced to the connector's body through a special high-resistance cable made up of seven stainless strands, and covered by anti-scratch teflon black tubing.

A lacing kit is supplied with every protection cap. In case a backup kit is needed, it can be ordered with the part number **SPXT-CAP**.

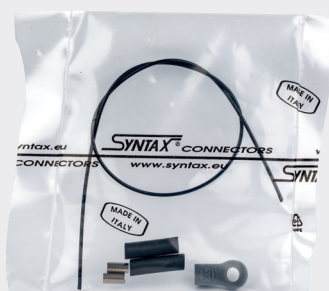

The kit now includes a new item: a special insulated housing specifically designed to allow cap lacing when panel connectors are rear mounted.



IP53 protective cover for drain
with special housing on caps for lacing
Part Number: **SPXDCCD-SC**



IP53 protective cover for source
with special housing on caps for lacing
Part Number: **SPXDCCS-SC**

IP53 Protection caps

The IP53 caps are fast, easy way to protect PowerSyntax connectors

The use of protective caps results in:

- Extended life span of the connectors as the mating faces are protected against impact damage and abrasion.
- Improved safety as contacts are protected against dust and water even when the connectors are not mated.

PART NUMBER EXPLANATION

PowerSyntax Line connectors version short and standard

Example Part Number

SPX 4 LD E GN 025 MQ



Connector Series

SPX Standard body
SPZ Short body

Maximum Current Rating

4 Up to 480amp (25 to 150mm²)
7 Up to 750amp (185 to 300mm²)
 - Crimp contact also available from 25 to 150mm² on request

Connector Style

LD Line Drain
LS Line Source

Key Composition

E Earth
N Neutral
1 Phase 1
2 Phase 2
3 Phase 3

Insulator Color

GN Green
BL Blue
BR Brown
BK Black
GY Gray
RD Red
YE Yellow
WH White

Contact Versions

Set-screw contact

025 25 mm²
035 35 mm²
050 50 mm²
070 70 mm²
095 95 mm²
120 120 mm²
150 150 mm²

Crimp contact (only SPX series)

165 120/150 mm² | internal Ø 16,5 mm | No. of crimpings 2
179 150/185 mm² | internal Ø 17,9 mm | No. of crimpings 2
197 185/240 mm² | internal Ø 19,7 mm | No. of crimpings 2
222 240/300 mm² | internal Ø 22,2 mm | No. of crimpings 3
237 300 mm² | internal Ø 23,7 mm | No. of crimpings 3

Cable Gland

MQ Reduced M40 gland Ø 15-23 mm
MP Normal M40 gland Ø 19-28 mm
MR Oversized M40 gland Ø 22-32 mm
MU M50 gland Ø 30-38 mm

Special Versions

Compatible accessories to be ordered separately

SPX-SYLOCK SyntaxLock quick secondary lock release system
SPXTKEY Secondary lock release key

SPXDSC-SC IP53 Protective plastic cap kit for source connectors
SPXDSD-SC IP53 Protective plastic cap kit for drain connectors
SPXDSC-SC-IP67 IP67 protection cap for source connectors
SPXDSD-SC-IP67 IP67 protection cap for drain connectors

SPX-RED025 Sleeve adapter for 25mm² set-screw contact
SPX-RED035 Sleeve adapter for 35mm² set-screw contact
SPX-RED050 Sleeve adapter for 50mm² set-screw contact
SPX-RED070 Sleeve adapter for 70mm² set-screw contact
SPX-RED095 Sleeve adapter for 95mm² set-screw contact

PART NUMBER EXPLANATION

PowerSyntax panel connectors

Example Part Number

SPX 4 PD E GN 150 MQ SO

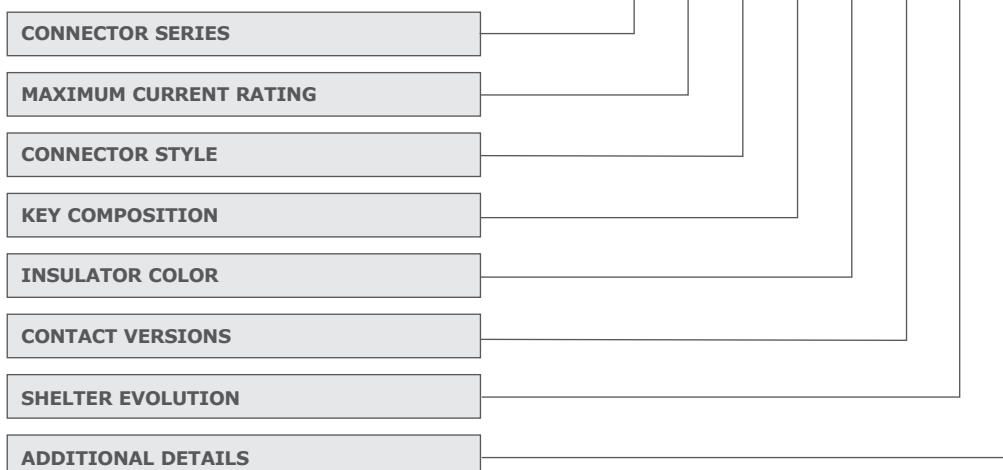

Connector Series

SPX Standard version

Maximum Current Rating

4 Up to 480amp (25 to 150mm²)
7 Up to 750amp (185 to 300mm²)



Connector Style

PD Panel Drain
PS Panel Source

Key Composition

E Earth
N Neutral
1 Phase 1
2 Phase 2
3 Phase 3

Insulator Color

GN Green 
BL Blue 
BR Brown 
BK Black 
GY Gray 
RD Red 
YE Yellow 
WH White 

Contact Versions

M02 Threaded M12 hole
M12 Threaded M12 post

Set-screw contact

025 25 mm²
035 35 mm²
050 50 mm²
070 70 mm²
095 95 mm²
120 120 mm²
150 150 mm²

Crimp contact

165 120/150 mm² | internal Ø 16,5 mm | No. of crimpings 2
179 150/185 mm² | internal Ø 17,9 mm | No. of crimpings 2
197 185/240 mm² | internal Ø 19,7 mm | No. of crimpings 2
222 240/300 mm² | internal Ø 22,2 mm | No. of crimpings 3
237 300 mm² | internal Ø 23,7 mm | No. of crimpings 3

Shelter Evolution or Legacy

00 Connector without Shelter
M4 Shelter Evolution/Legacy with M40 thread without cable gland
M5 Shelter Evolution with M50 thread without cable gland
MQ Shelter Evolution/Legacy with reduced M40 gland Ø 15-23 mm
MP Shelter Evolution/Legacy with normal M40 gland Ø 19-28 mm
MR Shelter Evolution/Legacy with oversized M40 gland Ø 22-32 mm
MU Shelter Evolution with M50 gland Ø 30-38 mm
 (to purchase just the Shelter Evolution add-on, please refer to its section on this website. Contact us for more information about the sizes)

Additional details

00 Shelter Legacy or No additional details
S0 Short backshell for Shelter Evolution
 (for Medium and long backshells see the Panel Lug Converters Part Number explanation)
T5 Brass M5 threaded inserts
 (4 inserts applied to the connector)
NF No flange

Compatible accessories to be ordered separately

SPX-SYLOCK SyntaxLock quick secondary lock release system
SPXTKEY Secondary lock release key

SPXDSC-SC IP53 Protective plastic cap kit for source connectors
SPXDSD-SC IP53 Protective plastic cap kit for drain connectors
SPXDSC-SC-IP67 IP67 protection cap for source connectors
SPXDSD-SC-IP67 IP67 protection cap for drain connectors

SPX-RED025 Sleeve adapter for 25mm² set-screw contact
SPX-RED035 Sleeve adapter for 35mm² set-screw contact
SPX-RED050 Sleeve adapter for 50mm² set-screw contact
SPX-RED070 Sleeve adapter for 70mm² set-screw contact
SPX-RED095 Sleeve adapter for 95mm² set-screw contact

PART NUMBER EXPLANATION

PowerSyntax Chain Pilot connectors with microswitch



Example Part Number

SCP 4 PD E GN 150 00T5

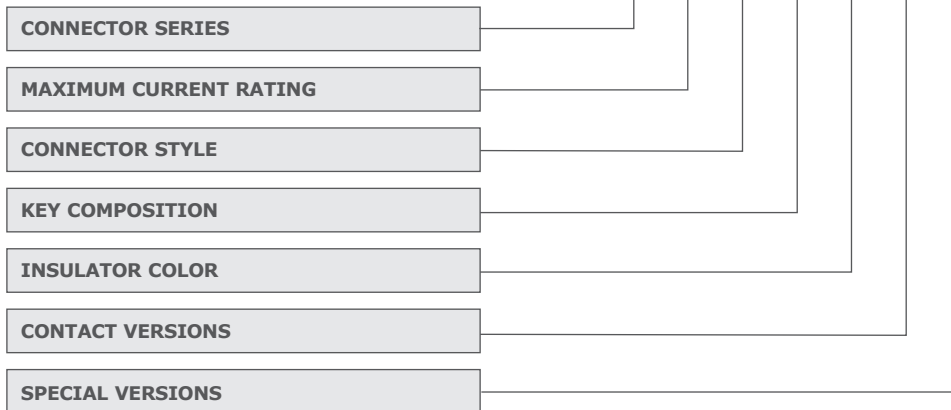

Connector Series

SCP Chain Pilot version

Maximum Current Rating

4 Up to 480amp (25 to 150mm²)
7 Up to 750amp (185 to 300mm²)

Connector Style

PD Panel Drain
PS Panel Source

Key Composition

E Earth
N Neutral
1 Phase 1
2 Phase 2
3 Phase 3

Insulator Color

GN Green
BL Blue
BR Brown
BK Black
GY Gray
RD Red
YE Yellow
WH White

Contact Versions

M02 Threaded M12 hole
M12 Threaded M12 post
M22 Extended length contact with threaded M12 hole
M32 Extended length contact with threaded M12 post

Set-screw contacts (Available on request)

025 25 mm² Set-screw contact
035 35 mm² Set-screw contact
050 50 mm² Set-screw contact
070 70 mm² Set-screw contact
095 95 mm² Set-screw contact
120 120 mm² Set-screw contact
150 150 mm² Set-screw contact

Crimp contacts (Available on request)

165 120/150 mm² | internal Ø 16,5 mm | No. of crimpings 2
179 150/185 mm² | internal Ø 17,9 mm | No. of crimpings 2
197 185/240 mm² | internal Ø 19,7 mm | No. of crimpings 2
222 240/300 mm² | internal Ø 22,2 mm | No. of crimpings 3
237 300 mm² | internal Ø 23,7 mm | No. of crimpings 3

Special Versions

00T5 Brass M5 threaded inserts
 (4 inserts applied to the connector)

Compatible accessories to be ordered separately

SPX-SYLOCK SyntaxLock quick secondary lock release system
SPXTKEY Secondary lock release key

SPXDCS-SC IP53 Protective plastic cap kit for source connectors
SPXDCD-SC IP53 Protective plastic cap kit for drain connectors
SPXDCS-SC-IP67 IP67 protection cap for source connectors
SPXDCD-SC-IP67-CP IP67 protection cap for drain connectors

SPX-RED025 Sleeve adapter for 25mm² set-screw contact
SPX-RED035 Sleeve adapter for 35mm² set-screw contact
SPX-RED050 Sleeve adapter for 50mm² set-screw contact
SPX-RED070 Sleeve adapter for 70mm² set-screw contact
SPX-RED095 Sleeve adapter for 95mm² set-screw contact

PART NUMBER EXPLANATION

Chain Pilot Box



Patented Chain Pilot connectors with microswitches are employed in our Chain Pilot Box

Example Part Number

SPB 4 D 04 EU D H S



Series

SPB Chain Pilot box version

Maximum Current Rating

4 480amp

7 750amp

Inside Connectors Style

D Drain

S Source

Poles compositions

04 L1 - L2 - L3 - PE

05 L1 - L2 - L3 - N - PE

22 Pos - Neg / Pos - Neg

Insulator Colors

EU Europe

AU Australia

UK United Kingdom

US United States

DC Two Batteries unit (Red - Black / Red - Black)

Included accessories

D IP67 Protection caps

Contact Versions

H Threaded M12 hole

P Threaded M12 post

Box Height

S 2 units

F 2,5 units

Compatible accessories to be ordered separately

SPX-SYLOCK SyntaxLock quick secondary lock release system

Spare parts

SPXDSC-SC-IP67 IP67 protection cap for source connectors

SPXDSC-SC-IP67-CP IP67 protection cap for drain connectors

SPXTKEY Secondary lock release key

PART NUMBER EXPLANATION

PowerSyntax 45 Panel connectors



Patented Chain Pilot connectors with microswitches can be employed in our PowerSyntax 45 series

Example Part Number

SCP 4 PD E GN M02 4500



Connector Series

SCP Chain Pilot version
SPX Basic version

Maximum Current Rating

4 Up to 480amp
7 Up to 750amp

Connector Style

PD Panel Drain
PS Panel Source

Key Composition

E Earth
N Neutral
1 Phase 1
2 Phase 2
3 Phase 3

Insulator Color

GN Green
BL Blue
BR Brown
BK Black
GY Gray
RD Red
YE Yellow
WH White

Contact Version

M02 Threaded M12 hole

Connector Version

4500 PowerSyntax 45

Compatible accessories to be ordered separately

SPX-SYLOCK SyntaxLock quick secondary lock release system
SPXTKEY Secondary lock release key

SPXDSC-SC IP53 Protective plastic cap kit for source connectors
SPXDSD-SC IP53 Protective plastic cap kit for drain connectors
SPXDSC-SC-IP67 IP67 protection cap for source connectors
SPXDSD-SC-IP67-CP IP67 protection cap for Chain Pilot drain connectors
SPXDSD-SC-IP67 IP67 protection cap for Basic drain connectors

PART NUMBER EXPLANATION

PowerSyntax 90 Panel connectors



Patented **Chain Pilot** connectors with microswitches can be employed in our PowerSyntax 90 series

Example Part Number

SCP 4 PD E GN M12 9000

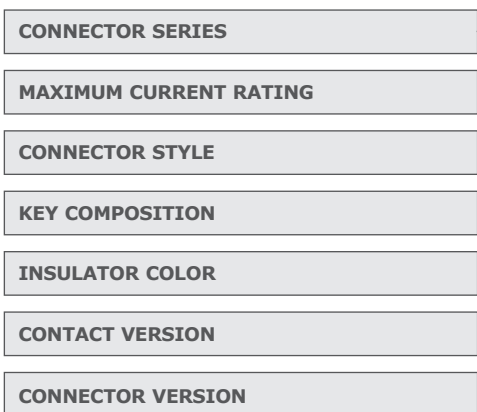

Connector Series

SCP Chain Pilot version
SPX Basic version

Maximum Current Rating

4 Up to 480amp
7 Up to 750amp

Connector Style

PD Panel Drain
PS Panel Source

Key Composition

E Earth
N Neutral
1 Phase 1
2 Phase 2
3 Phase 3

Insulator Color

GN Green
BL Blue
BR Brown
BK Black
GY Gray
RD Red
YE Yellow
WH White

Contact Version

M12 Threaded M12 post

Connector Version

9000 PowerSyntax 90

Compatible accessories to be ordered separately

SPX-SYLOCK SyntaxLock quick secondary lock release system
SPXTKEY Secondary lock release key

SPXDCS-SC IP53 Protective plastic cap kit for source connectors
SPXD-SC IP53 Protective plastic cap kit for drain connectors
SPXDCS-SC-IP67 IP67 protection cap for source connectors
SPXD-SC-IP67-CP IP67 protection cap for Chain Pilot drain connectors
SPXD-SC-IP67 IP67 protection cap for Basic drain connectors

PART NUMBER EXPLANATION

Lug Converters with SPY ComLug and EasiLug contacts - Line version

Example Part Number

SPY 4 LD E GN 1L 120 MQ



Connector Series

SPY for Lug Series

Maximum Current Rating

4 Up to 480amp (25 to 150mm²)
7 Up to 750amp (185 to 300mm²)





Connector Style

LD Line Drain
LS Line Source

Key Composition

E Earth
N Neutral
1 Phase 1
2 Phase 2
3 Phase 3

Insulator Color

GN Green 
BL Blue 
BR Brown 
BK Black 
GY Gray 
RD Red 
YE Yellow 
WH White 

Lug contact type and body

0L EasiLug without lug terminal (standard body)
1L EasiLug with lug terminal (standard body)
8L ComLug L Threaded M12 (standard body)
9H ComLug L2 Threaded M12 (oversized body)
9L ComLug XL Threaded M12 (oversized body)

Cable Conductor size for EasiLug terminal

000 Without EasiLug terminal / For ComLug L or XL
120 120 mm² aluminum cable
150 150 mm² aluminum cable
185 185 mm² aluminum cable
240 240 mm² aluminum cable
300 300 mm² aluminium cable

Cable Gland

MO NO cable gland
MQ Reduced M40 gland Ø 15-23 mm
MP Normal M40 gland Ø 19-28 mm
MR Oversized M40 gland Ø 22-32 mm
MU M50 gland Ø 30-38 mm

Special versions

00 No special version

Compatible accessories, to be ordered separately

SPX-SYLOCK SyntaxLock quick secondary lock release system
SPXTKEY Secondary lock release key

SPXDSCS-SC IP53 Protective plastic cap kit for source connectors

SPXDSD-SC IP53 Protective plastic cap kit for drain connectors

SPXDSCS-SC-IP67 IP67 protection cap for source connectors

SPXDSD-SC-IP67 IP67 protection cap for drain connectors

PART NUMBER EXPLANATION

Lug Converters with SPY ComLug and EasiLug contacts - Panel version

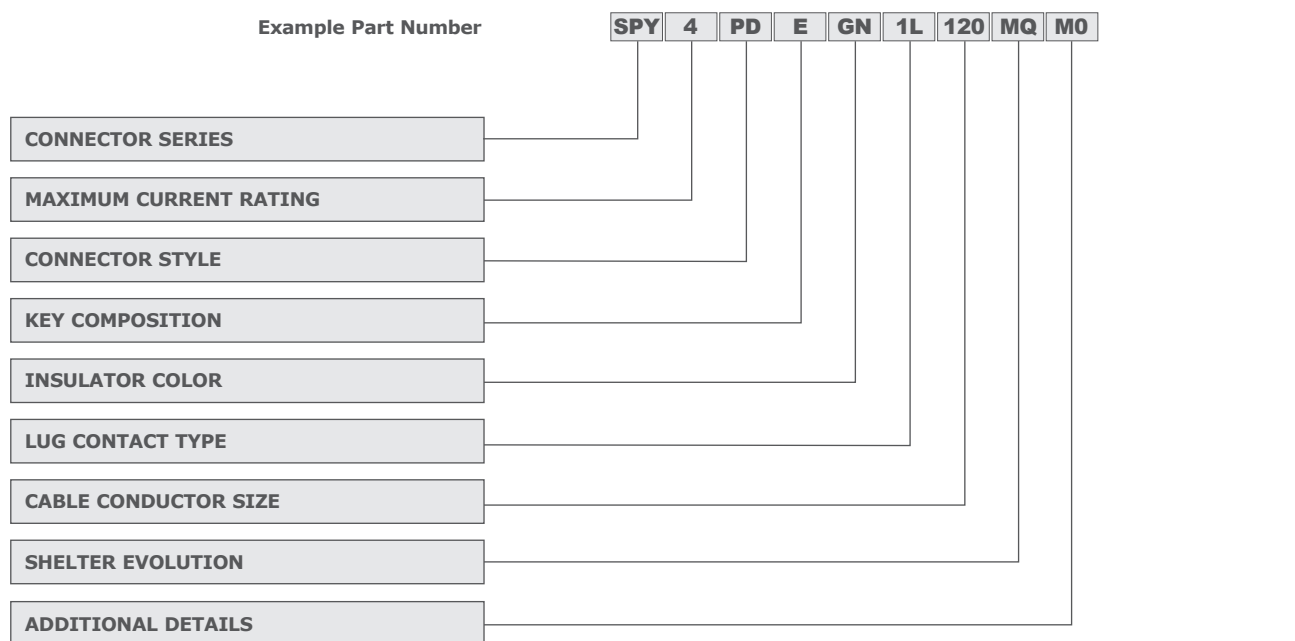

Connector Series

SPY for Lug Series

Maximum Current Rating

4 Up to 480amp (25 to 150mm²)

7 Up to 750amp (185 to 300mm²)

Connector Style

PD Panel Drain

PS Panel Source

Key Composition

E Earth

N Neutral

1 Phase 1

2 Phase 2

3 Phase 3

Insulator Color

GN Green

BL Blue

BR Brown

BK Black

GY Gray

RD Red

YE Yellow

WH White

Lug contact type

0L EasiLug without lug terminal

1L EasiLug with lug terminal

8L ComLug L Threaded M12 480amp

9H ComLug L2 Threaded M12

9L ComLug XL Threaded M12

Cable Conductor size for EasiLug terminal

000 Without EasiLug terminal / For ComLug L or XL

120 120 mm² aluminum cable

150 150 mm² aluminum cable

185 185 mm² aluminum cable

240 240 mm² aluminum cable

300 300 mm² aluminium cable

Shelter Evolution

00 Connector without Shelter Evolution

M4 Shelter Evolution with M40 thread and without cable gland

M5 Shelter Evolution with M50 thread and without cable gland

MQ Shelter Evolution with reduced M40 gland Ø 15-23 mm

MP Shelter Evolution with normal M40 gland Ø 19-28 mm

MR Shelter Evolution with oversized M40 gland Ø 22-32 mm

MU Shelter Evolution with M50 gland Ø 30-38 mm

(to purchase just the Shelter Evolution add-on, please refer to its section on this website. Contact us for more information about the sizes)

Additional details

00 No additional details

M0 Medium backshell for Shelter Evolution

L0 Long backshell for Shelter Evolution

(for Short backshell see the Panel connectors Part Number explanation)

Compatible accessories, to be ordered separately

SPX-SYLOCK SyntaxLock quick secondary lock release system

SPXTKEY Secondary lock release key

SPXDSC-SC IP53 Protective plastic cap kit for source connectors

SPXDSD-SC IP53 Protective plastic cap kit for drain connectors

SPXDSC-SC-IP67 IP67 protection cap for source connectors

SPXDSD-SC-IP67 IP67 protection cap for drain connectors



Tell us what you need and we'll build it for you

In our mechanical workshop we are free to innovate and independently create and test new solutions, thanks to highly skilled designers and state-of-the-art machines.
An ability of ours and a great advantage for our clients.

From basic customizations to whole new connector designs,
we are ready to give shape to your needs.

Let's discuss your new idea together.



www.valentininet.com



**Genuine
Italian
Products**

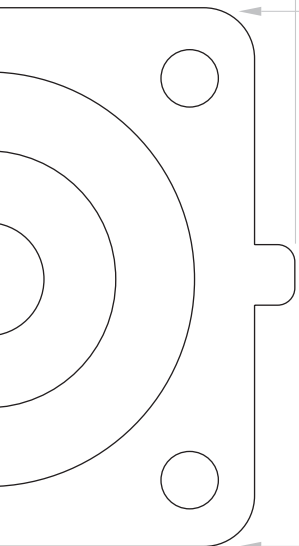

VALENTINI

Via Asti 88/A
10098 Rivoli (TO) Italy
Tel: +39 0119594160

info@syntaxnet.it
www.valentininet.com
www.powersyntaxconnectors.com
[linkedin.com/company/valentinigroup](https://www.linkedin.com/company/valentinigroup)

SYNTAX®



PowerSyntax website