

FRONT

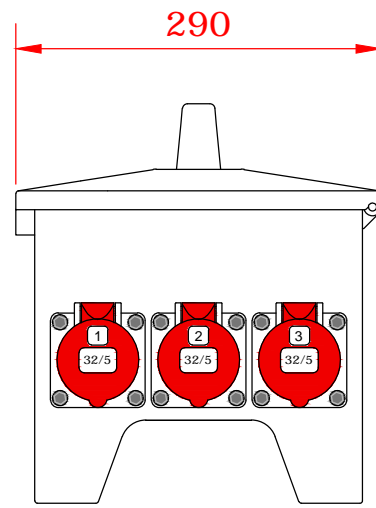

RIGHT

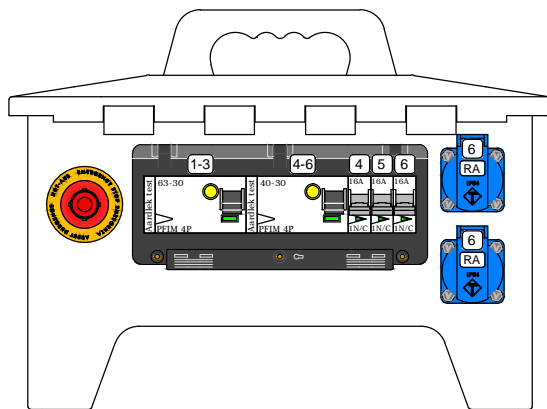

BACK

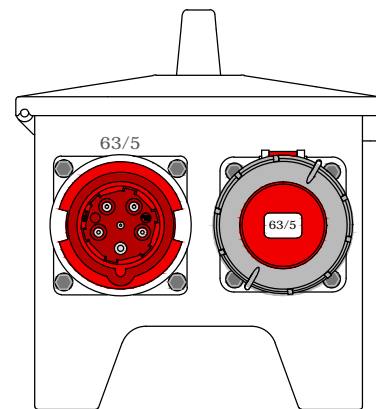

LEFT

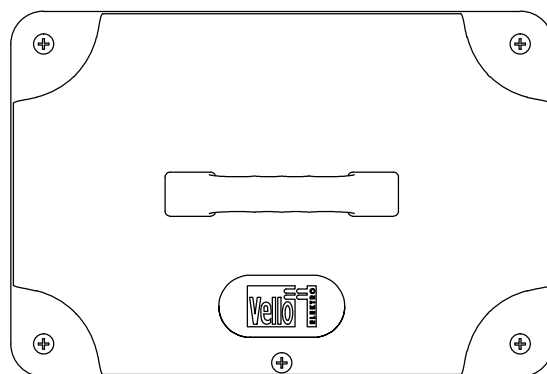

TOP



Vello Elektro BV
 Typograaf 14
 6921 VB Duiven NL
 +31(0)316 251500

Project:

V40.2.0052-D

A4

				Date	Name	Material: Rubber	Frame: -	Page 1
			Design	26.09.2018	EP	Type: V40		
			Check			V40.2 63A		Of 1
			Adjustment					
NR.	Modified	Date	Name		Scale 1:5	Measurements in mm	Weight ca. 13 Kg	